



USER GUIDE

A downloadable, printable guide to your Alcatel GO FLIP and its features.

alcatel
GO FLIP™

TABLE OF CONTENTS

GETTING STARTED	1
Introduction	2
About the User Guide	2
Set Up Your Phone	3
Parts and Functions	3
Battery Use	4
Insert the Battery	4
Remove the Battery	5
Charge the Battery	6
SIM Card	8
SD Card	9
Insert an SD Card	10
Remove an SD Card	10
Turn Your Phone On and Off	12
Activation and Service	13
Complete the Setup Screens	13
Basic Operations	15
Basics	15
Home Screen and Applications (Apps) List	15
Phone Settings Menu	15
Capture Screenshots	16
Applications	16
Launch Applications	16
Apps List	17
Phone Number	18
Airplane Mode	18
Enter Text	19
Lock and Unlock Your Screen	20
Update Your Phone	20
Update Your Phone Software	20
Update Your Profile	21
Update Your PRL	22
Your Phone's Home Screen	23

Home Screen Basics	23
Status Bar	23
Change the Home Screen Wallpaper	24
MAKING CONNECTIONS	26
Phone Calls and Voicemail	27
Place and Answer Calls	27
Call Using the Phone Dialer	27
Call Emergency Numbers	29
Answer Phone Calls	29
In-Call Screen Layout and Operations	30
Place a Call from Contacts	31
Call from Call Log	32
Voicemail	33
Voicemail Setup	33
Optional Calling Services	34
Call Waiting	34
Conference Calling	34
Call Forwarding	35
Call Settings	36
Contacts	38
Add a Contact	38
View Contacts	40
Contacts Screen Layout	41
Edit a Contact	42
Delete a Contact	42
Share a Contact	43
Import Contacts	44
Back Up Contacts	45
Messaging	46
Text and Multimedia Messaging	46
Send a Text Message	46
Send a Multimedia Message (MMS)	47
Save and Resume a Draft Message	48
New Messages Notification	48
Manage Message Conversations	48
Text and MMS Options	49

E-mail	50
Set Up an E-mail Account	50
Add Another E-mail Account	50
Create and Send E-mail	51
Open E-mail Messages	52
Delete an E-mail Account	54
Manage Your Email Inbox	54
Internet	56
Data Connection Status and Indicators	56
Browser	56
Use the Browser	56
Browser Options	57
Connectivity	59
Wi-Fi	59
Turn Wi-Fi On and Connect to a Wireless Network	59
Wi-Fi Settings	60
Disconnect Wi-Fi	61
Bluetooth	61
Bluetooth Information	62
Enable the Bluetooth Feature	62
Pair Bluetooth Devices	63
Connect to a Paired Bluetooth Device	64
Send Information Using Bluetooth	65
Receive Information via Bluetooth	66
APPS AND ENTERTAINMENT	67
Camera and Video	68
Camera Overview	68
Take Pictures and Record Videos	69
Take a Picture	69
Record Videos	70
View Pictures and Videos Using Gallery	71
Edit Pictures	72
Share Pictures and Videos	74
Send Pictures or Videos by Email, Messages or Bluetooth	74
Camera Settings	76
Switch Between Camera and Video Mode	76

Set Camera Functions	76
Productivity	78
Calendar	78
Add an Event to the Calendar	78
View Calendar Events	79
Sync Calendars	80
Calculator	81
Clock	81
Set Alarms	82
Additional Clock Features	83
Entertainment and Activities	85
Play Music	85
Music Screen Layout	86
SETTINGS	87
Connections Settings	88
Basic Settings	88
Wi-Fi Settings Menu	89
Bluetooth Settings	91
Cellular and Data	92
Personalization Settings	94
Sound Settings	94
Display Settings	95
Search Settings	95
Notices Settings	96
Date and Time Settings	97
Language Settings	98
Input Methods Settings	99
Privacy and Security Settings	101
Screen Lock Settings	101
App Permission Settings	101
Do Not Track Settings	102
Browsing Privacy Settings	103
Storage Settings	104
USB Storage Settings	104
Media Storage Settings	104
Device Settings	106

Device Information Settings	106
Downloads Settings	107
Battery Settings	108
Accessibility Settings	108
System Updates Settings	109
GETTING HELP	111
For Assistance	112
Troubleshooting	112
Specifications	112
Virgin Account Information and Help	113
Manage Your Account	113
Re-Virgin	114
Copyright Information	114
INDEX	115

GETTING STARTED

The topics in this section will introduce you to your phone, help you get set up with service, provide an overview of the phone screen, and get you started with basic phone operations.

INTRODUCTION

The following topics describe the basics of using this guide and your new phone.

ABOUT THE USER GUIDE

Thank you for purchasing your new Alcatel GO FLIP. The following topics explain how best to use this guide to get the most out of your phone.

Before Using Your Phone

Read the Get Started guide and Important Information booklet that were packaged with your phone thoroughly for proper usage.

Accessible services may be limited by subscription contract conditions.

Descriptions in the User Guide

Note that most descriptions in this guide are based on your phone's setup at the time of purchase. Unless otherwise noted, instructions begin from the phone's home screen, which is displayed by pressing the **End/power key** . Some operation descriptions may be simplified.

Screenshots and Key Labels

Screenshots and other illustrations in this user guide may appear differently on your phone. Key labels in the user guide are simplified for description purposes and differ from your phone's display.

Other Notations

In the user guide, the phone may be referred to either as "phone," "device," or "handset." A microSD™ or microSDHC™ card is referred to as an "SD card" or a "memory card."

SET UP YOUR PHONE

The following topics give you all the information you need to set up your phone and wireless service the first time.

PARTS AND FUNCTIONS

These topics illustrate your phone’s primary parts and key functions.





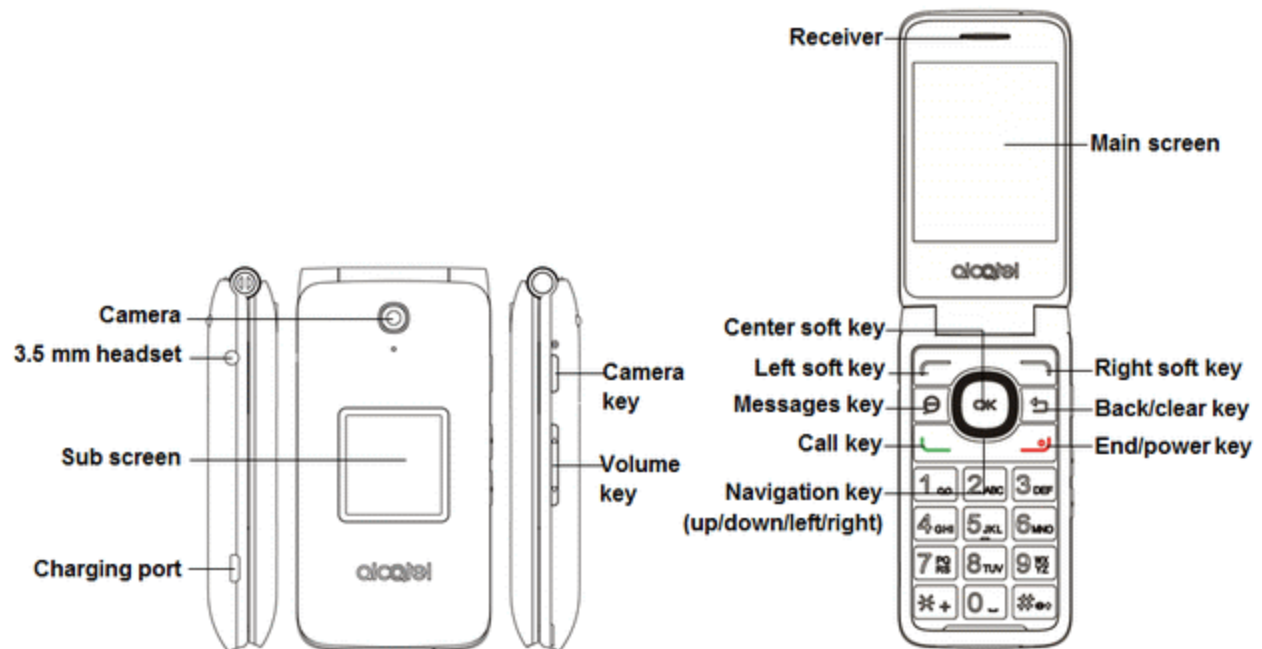

Note: Your phone's screens and apps layouts are subject to change. This user guide uses sample images only.

Phone Layout

The following illustration outlines your phone’s primary external features and keys.



Part	Description
Camera	Takes pictures and records videos.
Receiver	Lets you hear the caller and automated prompts.
Main screen	Displays all the information needed to operate your phone, such as the call status, the Contacts list, and the date and time.
Sub screen	Display the date, time and the notification of incoming calls or messages.

Part	Description
Center soft key 	Selects or confirms an option (press the middle of the key).
Navigation key 	Navigate Up, Down, Left, or Right through menus.
Messages key 	Launches the messages screen from any screen.
Call key 	Launches call log from idle screen.
Back/clear key 	Returns you to the previous screen, or close a dialog box, options menu.
End/power key 	Returns you to the app list or turn the phone on or off.
Charging port	Allows you to connect the phone charger.
Volume keys	Allows you to adjust the ringtone or media volume or adjust the voice volume during a call.
3.5 mm headset jack	Allows you to plug in either a stereo headset or an optional headset for convenient, hands-free conversations.

CAUTION! Inserting an accessory into the incorrect jack may damage the phone.

BATTERY USE

The following topics explain how to insert and remove your phone's battery.

Battery Cautions

Storage: Avoid storing or leaving battery with no charge remaining. Saved information and settings may become lost or changed, or battery may become unusable. Charge once every six months before storing or leaving unused for a long period.

Bulges: Depending on use, bulges may appear near end of battery life. This does not affect safety.

Replacing Battery: The battery is a consumable item. It needs to be replaced if operating time shortens noticeably. Purchase a new battery.

Cleaning: Clean soiled terminals between battery and phone with a clean, dry cotton swab. Soiled terminals can result in a poor connection and prevent charging, etc.

Insert the Battery

Follow these instructions to insert your phone's battery safely and properly.

1. Remove the battery cover by gently lifting in the direction shown below.

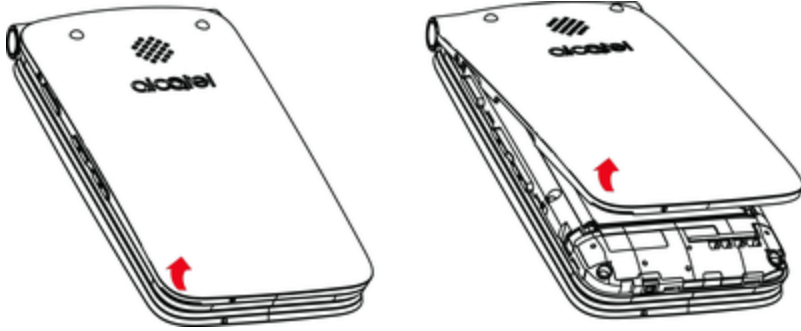

2. Insert the battery by gently lifting upward as shown below.

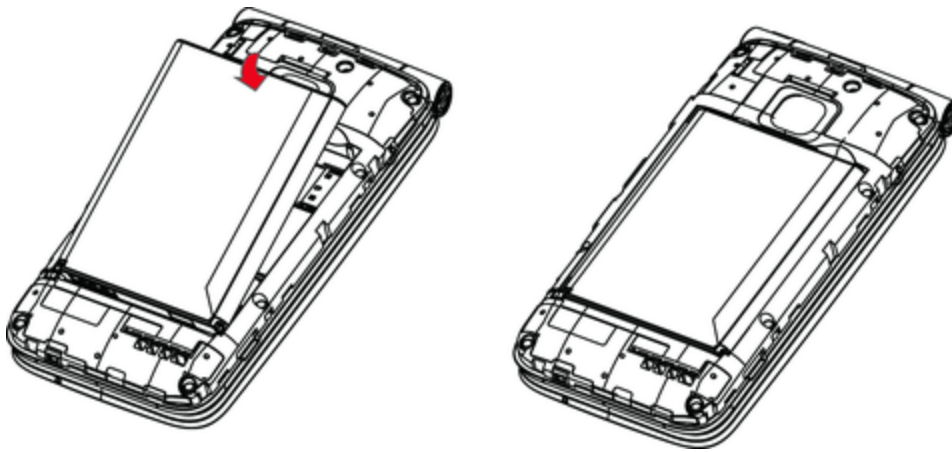

3. Attach the battery cover.

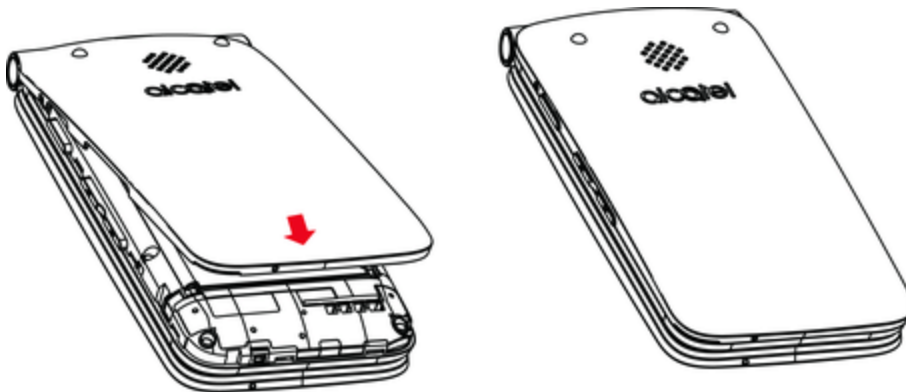

- Make sure all the tabs are secure and there are no gaps around the cover.

Remove the Battery

Follow these instructions to remove your phone's battery. Always power the phone off before removing the battery.

1. Remove the battery cover by gently lifting in the direction shown below.

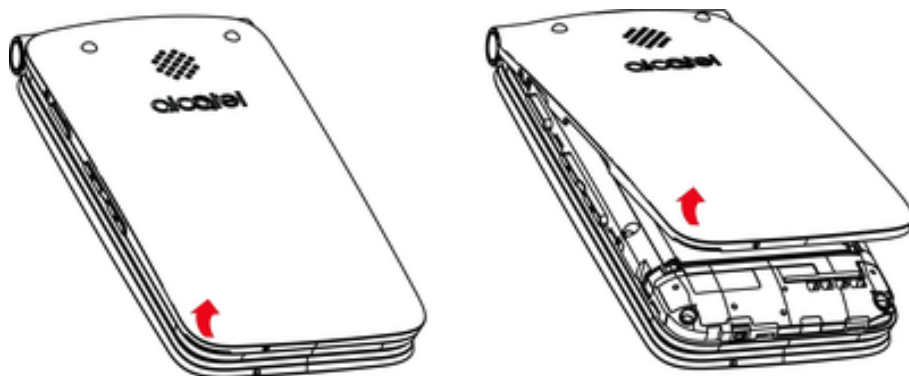

2. Remove the battery by gently lifting upward as shown.

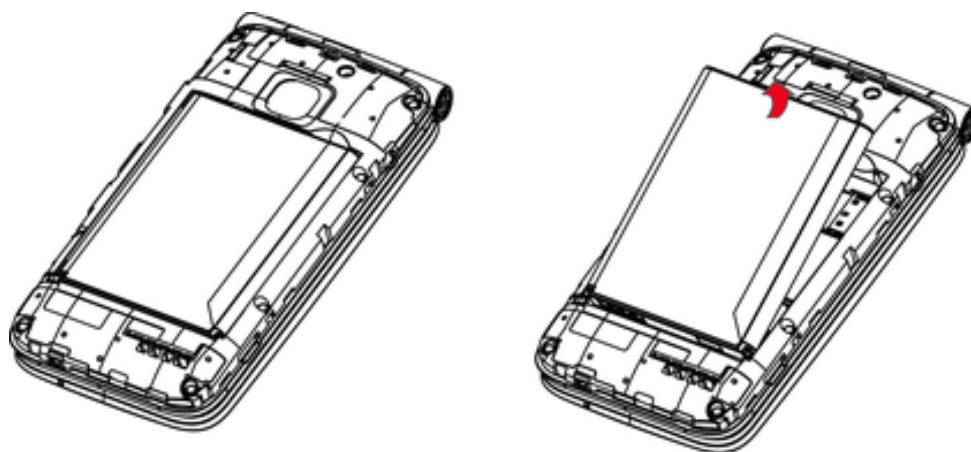

Charge the Battery

Follow these instructions to charge your phone's battery using either the included AC adapter or via a USB connection on your computer.

Charge Using the AC Adapter

1. Plug the charger into the charging port of your phone.

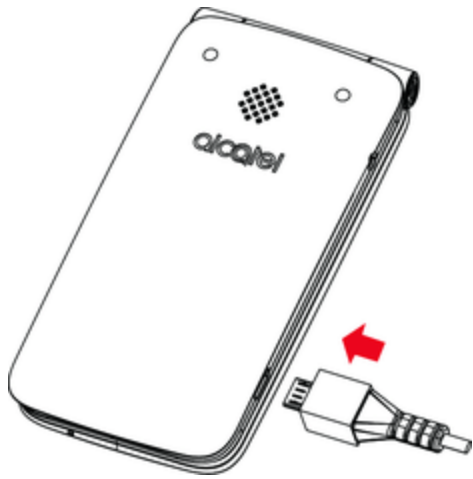

2. Plug the AC adapter into an electrical outlet.
3. After charging, unplug the AC adapter from the outlet and remove the charger from the phone.



Charge Using a PC Connection

Before using a PC connection to charge your phone, ensure that the computer is turned on. Depending on the type of connection, your phone's battery may not charge.

1. Insert the small end of the USB cord into the charging port of your phone.
2. Insert the large end of the USB cord into an external USB port on your computer.



3. After charging, remove the USB cable from both the phone and the computer.

SIM CARD

The SIM card is an IC card containing phone number and other customer information. Your phone's SIM card is preinstalled and should only be accessed if directed by a customer service representative.

Handling a SIM Card

Keep the following in mind when handling a SIM card.

- You are responsible for any damage caused by inserting the SIM card in another-brand IC card reader, etc. Virgin is not responsible in such a case.
- Always keep the IC chip clean.
- Wipe clean with a dry, soft cloth.
- Avoid applying labels. May damage SIM card.
- See instructions included with SIM card for handling.
- The SIM card is the property of Virgin.
- The SIM card is replaceable (at cost) in case of loss/damage.
- Return the SIM card to Virgin when canceling subscription.
- Returned SIM cards are recycled for environmental purposes.
- Note that SIM card specifications and performance may change without notice.
- It is recommended that you keep a separate copy of information that is stored on SIM card. Virgin is not responsible for damages from stored information that is lost.

- Always follow emergency procedures to suspend service if your SIM card or phone (SIM card inserted) is lost or stolen. For details, contact Customer Service.
- Always power off the phone before inserting/removing the SIM card.

Insert SIM Card

Follow these instructions to insert a SIM card. Remember to power off your phone before inserting a SIM card.

Note: Your phone's SIM card is preinstalled. These instructions are for reference only.

1. Remove the battery cover and battery. (See [Remove the Battery](#).)
2. Gently insert the SIM card with the gold IC chip facing downward.

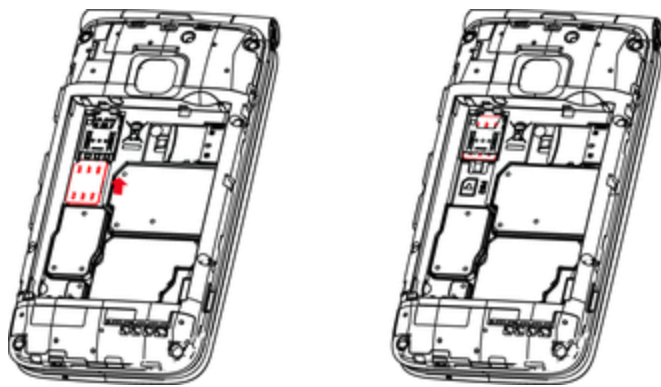

3. Insert the battery and replace the battery cover. (See [Insert the Battery](#).)
 - Align the contacts of the battery with the contacts in the phone.
 - Make sure all the tabs are secure and there are no gaps around the cover.

SD CARD

Your phone supports the use of an optional SD card (not included) to expand its storage capacity. It supports cards up to 32 GB. Some cards may not operate properly with your phone.

! SD Card Cautions

Data: Information stored on an SD card can become lost or changed accidentally or as a result of damage. It is recommended that you keep a separate copy of important data. Virgin is not responsible for damages from data that is lost or changed.

Reading/Writing Data: Never power off or remove the battery while reading or writing data.

Battery Level: A low battery charge may prevent reading/writing to an SD card.

Handling SD Card: Use/store SD cards away from the reach of infants, otherwise it may cause choking if swallowed.

Insert an SD Card

Follow these steps to insert an optional SD card (not included).

Important: Make sure to power your phone off before inserting or removing an SD card.

1. Remove the battery cover and battery. (See [Remove the Battery](#).)
2. Gently insert the SD card with terminals facing down all the way without bending the card.

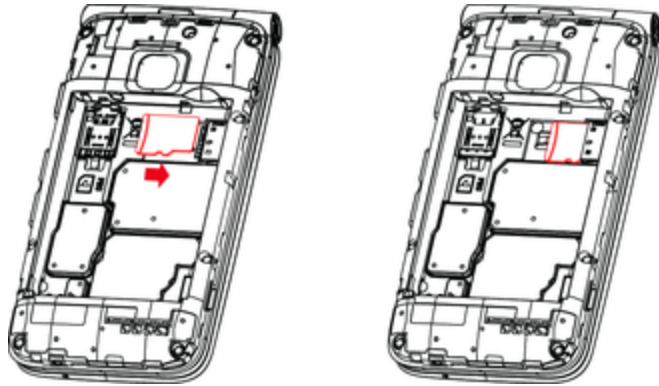

Important: Insert only SD cards.

3. Insert the battery and replace the battery cover. (See [Insert the Battery](#).)
 - Align the contacts of the battery with the contacts in the phone.
 - Make sure all the tabs are secure and there are no gaps around the cover.

Remove an SD Card

Follow these instructions to remove an SD card.

Important: Always power off before inserting or removing an SD card.

1. Remove the battery cover by gently lifting in the direction shown below.

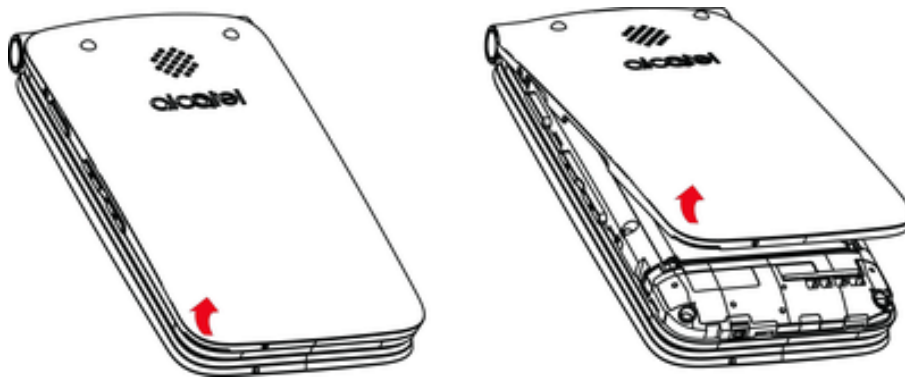

2. Remove the battery.

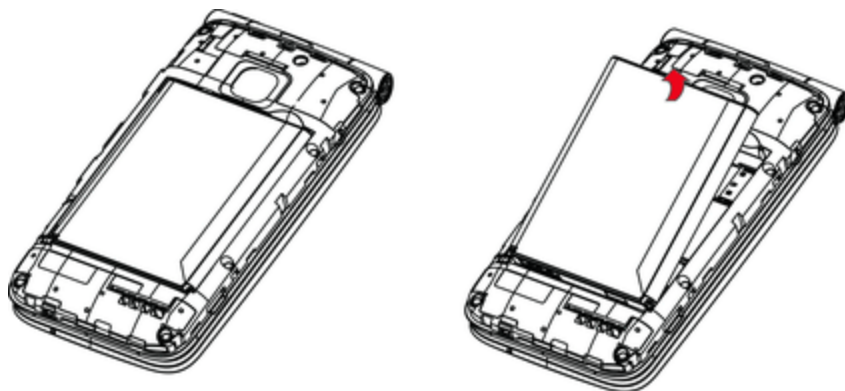

3. Push down on the plastic spring and remove SD card.

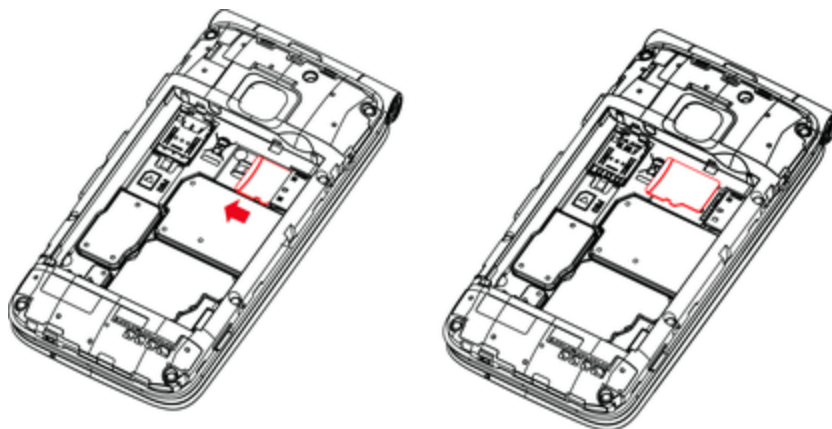

4. Insert the battery. Align the contacts of the battery with the contacts in the phone.

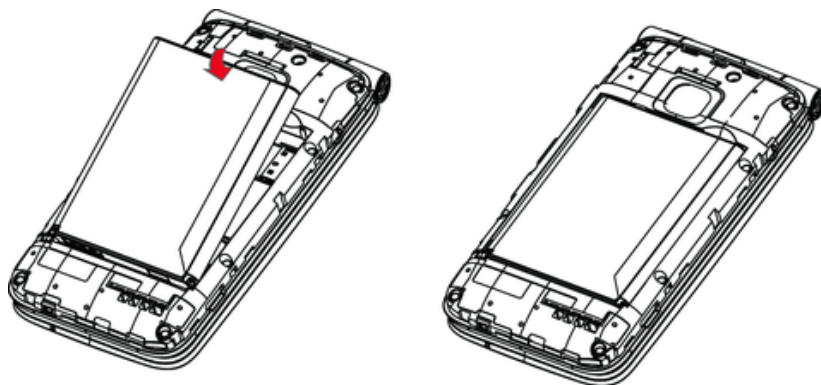

5. Attach the battery cover. Make sure all the tabs are secure and there are no gaps around the cover.

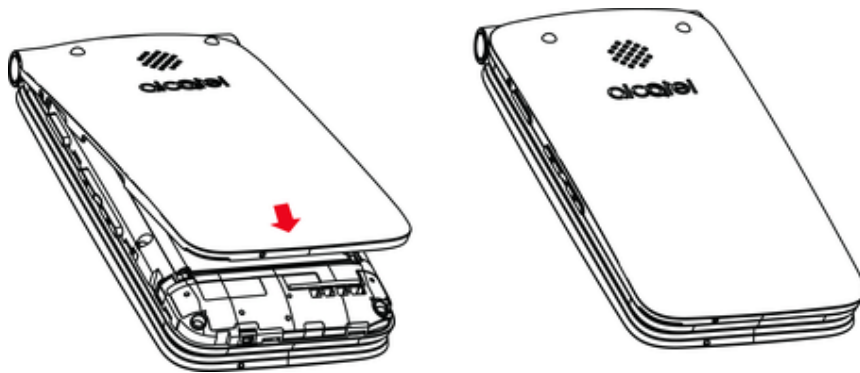

TURN YOUR PHONE ON AND OFF

The instructions below explain how to turn your phone on and off.

Turn Your Phone On

- Press and hold the **End/power key** .

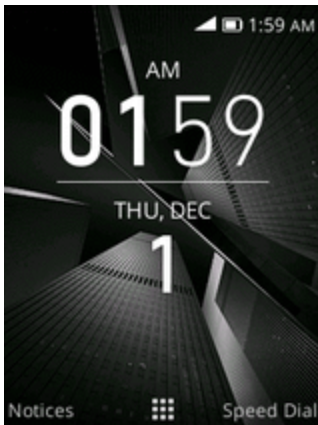

- ❖ Your phone will power on. Depending on the settings, you may see the lock screen.
 - See [Lock and Unlock Your Screen](#) and [Screen Lock Settings](#) for information about using the screen lock.
 - The first time you turn the phone on, you will see the startup screens. See [Complete the Setup Screens](#) for details.
 - If your phone is not yet activated, see [Activation and Service](#) for more information.

Turn Your Phone Off

- Press and hold the **End/power key** .
- ❖ Your phone will power off.

Note: Your screen remains blank while your phone is off (unless the battery is charging).

ACTIVATION AND SERVICE

Before using your phone, you must set up your service with Virgin. You will need your phone's serial numbers (MEID and ICC ID). These numbers can be found on the phone's packaging.

For more information about your Virgin account, see [Virgin Account Information and Help](#).

Create Your Account and Pick Your Plan

Set up your Virgin account.

1. From your computer, visit Virginmobileusa.com and click **Activate**.
2. Choose an activation option and click **Next**.
3. When prompted, enter the serial number (MEID) printed on the sticker located on the back of your phone in the battery compartment. This number can also be found on the bottom panel of the phone's package.
4. Follow the remaining instructions to choose your plan and select a payment method.
5. Follow the activation instructions below and you'll be able to start using your phone.

Activate Your Phone

After setting up your account on Virginmobileusa.com, simply turn your device on. Your device is designed to activate automatically. If you are swapping from another Virgin device to a new one, be sure to turn off the old device before swapping the serial number (MEID). Once the MEID swap is complete, turn on the new device and the programming information will be pushed to your device automatically.



COMPLETE THE SETUP SCREENS

The setup screens help you set up certain features and preferences on your phone. Once your phone has been turned on, you will see a Welcome message. You can then complete the setup process.

Note: You may be able to complete the setup screens before your phone has been activated on your account.

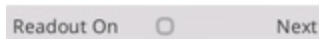
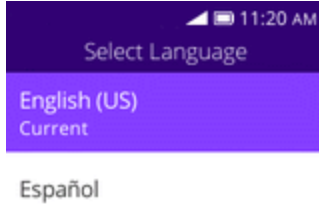
1. From the Welcome screen, select a language and press the **Right soft key**  to get started.



- To skip any section, press the **Right soft key**  to skip.
2. Follow the onscreen instructions to complete each section. For each topic, you will have the option to skip it and continue to the next screen.
 - **Select a network** – If prompted, follow the prompts to sign in to an available Wi-Fi network. For secured Wi-Fi networks, you will need to enter a password. See [Wi-Fi](#) for more details.
 - **Setup KaiOS Account** – Use the **Navigation** key to select **Create Account** to set up a new KaiOS Account or **Login Account** and complete the steps to sign in to your current KaiOS Account. Press the **Right soft key**  to skip. The following options may apply depending on your selection:
 - **Create Account** – Follow the instructions to sign up for a new KaiOS Account.
 - **Login Account** – Enter your KaiOS Account address and password and sign in to your current KaiOS Account.
 - **About KaiOS** – Read any applicable Terms and Conditions of KaiOS system for using your phone, press the **Right soft key**  to agree to the terms of service and privacy policy.
 3. Your setup is now complete.
 - ❖ Your phone is now set up for use. If you skipped any part of the setup, you can access additional options through the Apps screen or through Settings.

BASIC OPERATIONS



The following topics outline basic features and operations of your phone.

BASICS

The following topics offer an overview of your phone's basic operations.

Home Screen and Applications (Apps) List

Most of your phone's operations originate from the home screen or the apps list.

1. Press the **End/power** key  until display the home screen.
2. From any app screen press the **End/power** key  to display the app list.

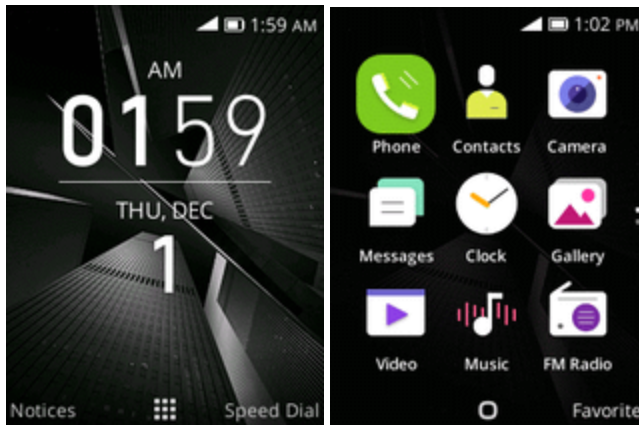

For information about using the home screen, see [Home Screen Basics](#).

Phone Settings Menu

You can customize your phone's settings and options through the Settings menu.

- From the apps list screen, select **Settings** .

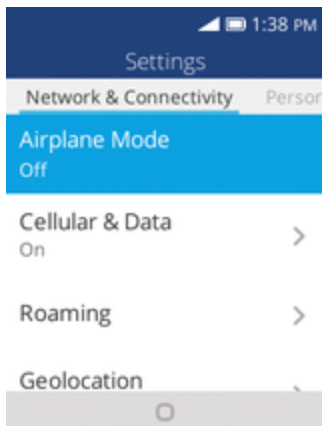

For more information, see [Basic Settings](#).

Capture Screenshots

You can use your phone's End/power and home keys to capture screenshots.

- Press and hold the **Camera** key and **Volume down** key at the same time to capture a screenshot of the current screen.
- ❖ The current screenshot will be captured and stored in the Screenshots album in the phone's Gallery application. From the apps list screen, select **Gallery** .

APPLICATIONS

The following topics describe how to access the applications (apps) list and launch apps on your phone.

Launch Applications

All installed apps can be accessed and launched from the apps list.

1. From home, press the **Center soft key** .

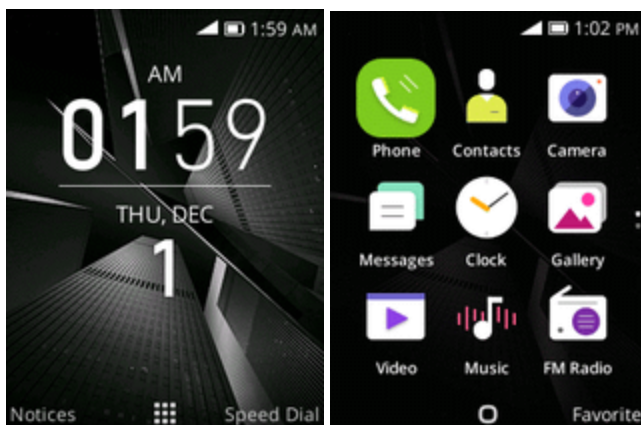









- ❖ The apps list opens.





2. Use the **Navigation** key to select an application and then press  to launch the corresponding application.

- ❖ The application opens.

Apps List

The apps list expands to include all apps installed on your phone. The following table outlines the primary apps that have been preinstalled on your phone.

App	Function/Service
 Calculator	Perform basic mathematical calculations.
 Calendar	Create and manage events, meetings, and appointments, organize your time and reminds you of important events.
 Phone	Place and receive calls, use voicemail, set up and manage contacts, and more.
 Camera/Video	Take and share pictures and videos.
 Clock	Set alarms, use a stopwatch, set a timer.
 Contacts	Manage your contacts from a variety of sources.
 FM Radio	Lets you listen to the radios.
 Browser	A browser you can use to surf on the Internet.

App	Function/Service
 Gallery	Manage your photos and videos.
 E-Mail	Send, receive, and manage your Email messages.
 Messages	Send and receive instant text messages.
 Music	Lets you browse and play music.
 Settings	Provide an overview of items you can change through Settings.

PHONE NUMBER

Follow the instructions below to display your phone's wireless phone number.

1. From the apps list, select **Settings**  > **Device** > **Device Information**.
2. Select **Phone Number**.

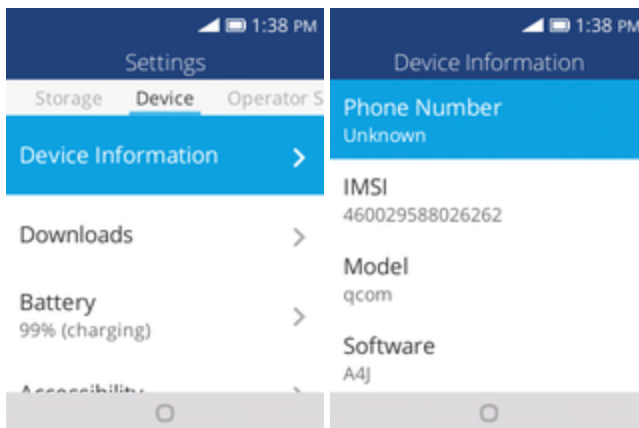

- ❖ You will see the number listed under **Phone number**.

AIRPLANE MODE

Airplane mode turns off all functions that emit or receive signals, while leaving your phone on so you can use apps that don't require a signal or data.

To turn on airplane mode:

1. From the apps list, select **Settings**  > **Network & Connectivity**.
2. Select **Airplane Mode**.
3. Select **On** to enable airplane mode.

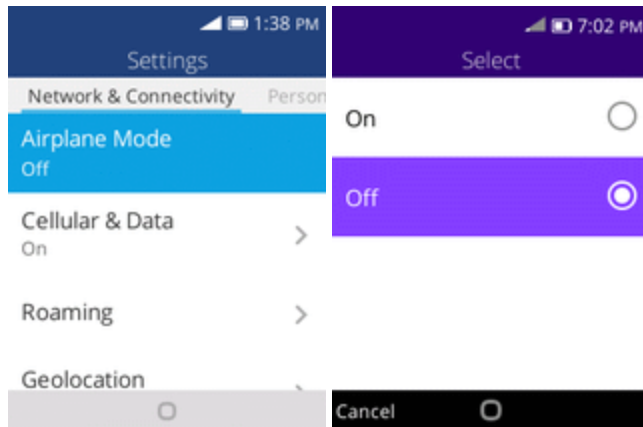

❖ Your phone is now in airplane mode. You will see the airplane mode icon  in the status bar.

To turn off airplane mode:

1. From the apps list, select **Settings**  > **Network & Connectivity**.
2. Select **Airplane mode**.
3. Select **Off** to disable airplane mode.





❖ Your phone's wireless connection features are now restored.

ENTER TEXT

You can enter text using your phone's Nuance T9 keyboard.

Text Input

Your phone offers you a choice of using normal or predictive text input. To select your desired input:

1. From the apps list, select **Settings**  > **Personalization** > **Input methods**.
2. Press  to switch among "Abc/abc/ABC" mode.
3. To insert a punctuation mark or special character, please press .
4. If you want to delete typed letters or symbols press the **Back/clear** key  to delete them one by one.

LOCK AND UNLOCK YOUR SCREEN

Your phone allows you to quickly turn the screen on/off when you unfold/fold the phone, or you can set up screen lock to prevent others from using your phone without your permission.

Turn the Screen Off When Not in Use

- To quickly turn the screen off, simply fold (close) the phone..

To save battery power, the phone automatically turns off the screen after a certain period of time when you leave it idle. You will still be able to receive messages and calls while the phone's screen is off.

Note: For information on how to adjust the time before the screen turns off, see [Display Settings](#).

Turn the Screen Lock On or Off

1. From the apps list, select **Settings**  > **Privacy & Security** > **Screen Lock**.
2. Select **On** to enable screen lock
3. You will be prompted to enter the passcode. See [Screen Lock Settings](#).

UPDATE YOUR PHONE

From time to time, updates may become available for your phone. You can apply updates through the **Settings**  > **Device** > **System Updates** menu.

Software Update Cautions

During update: The phone cannot be used until the software update is complete. It may take time to update your phone's software.

Signal during update: Update your phone where signal reception is good, and do not change location during the update process. Make sure the battery is adequately charged before beginning an update. A weak signal or low battery during an update may cause the update to fail. An update failure may disable the phone.

Other functions during update: Other phone functions cannot be used during a software update.

Update Your Phone Software

You can update your phone's software using the System Updates option.

1. From the apps list, select **Settings**  > **Device** > **System Updates**.

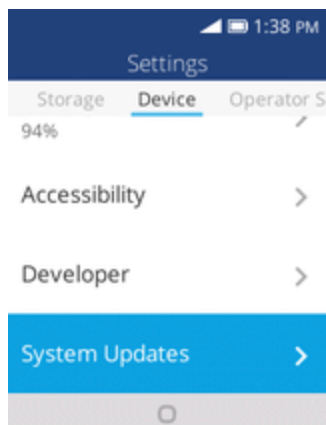

2. Select **System Updates**.

❖ You may be required to power your phone off and back on to complete the software upgrade.

Confirm Your Current Phone Software

1. From the apps list, select **Settings**  > **Device** > **Device Information**.
2. Locate the Software version read-only field.

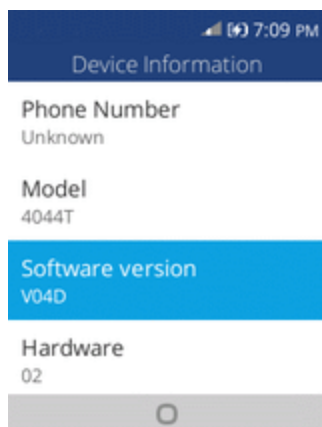

Update Your Profile

This option allows you to automatically update your online user profile information. If you choose to change your user name and select a new one online, you must then update the user name on your phone.

1. From the apps list, select **Settings**  > **Device** > **System Updates** > **Update Profile**.

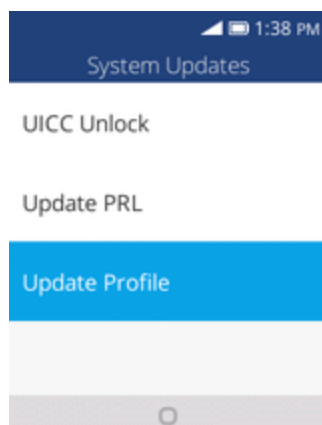

2. Follow the onscreen instructions.

- ❖ The phone will download and install the profile update and you will see a confirmation when complete.

Note: If your data services or account syncing ever seems to go out unexpectedly, use this feature to reconnect with the network.

Update Your PRL

This option allows you to download and update the PRL (preferred roaming list) automatically.

1. From the apps list, select **Settings**  > **Device** > **System Updates** > **Update PRL**.

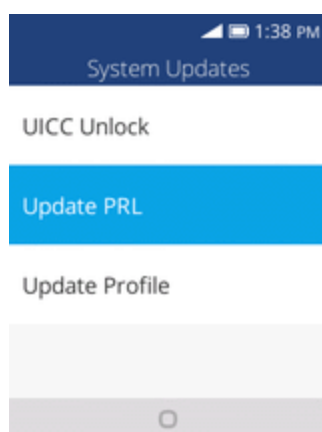

2. Follow the onscreen instructions.

- ❖ The phone will download and install the PRL update and you will see a confirmation when complete.

YOUR PHONE'S HOME SCREEN

The following topics describe how to use your phone's home screen and understand the status bar.



HOME SCREEN BASICS

The home screen is the starting point for your phone's applications, functions, and menus.

Home Screen Layout

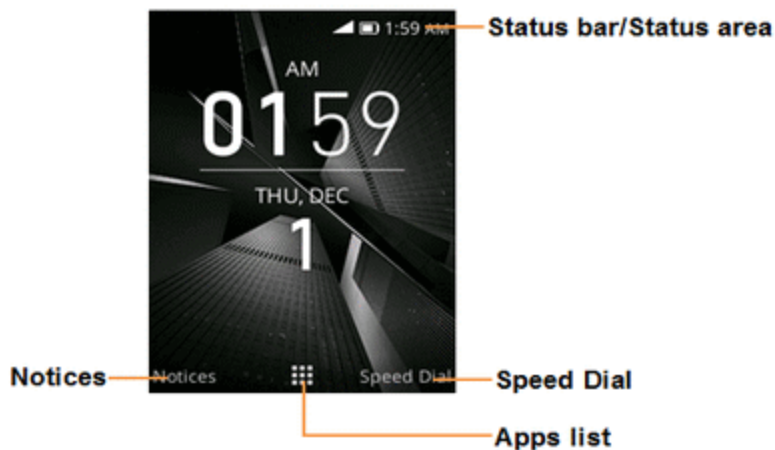
Below is your home screen's layout.



Item	Description
Status bar/Status area	The status bar displays icons to notify you of your phone's status (on the right side) and notifications (on the left side). The status area of the status bar (on the right) displays phone and service status information such as signal strength, battery status, Wi-Fi and data connectivity, ringer status, and time.
Notices	Press the Left soft key  to view numerical notifications (missed call, new mail, new message, etc.).
Apps list	Press the Center soft key  to enter the apps list.
Speed Dial	Press the Right soft key  to enter speed dial.

Tip: Press the **End/power key**  to return to the main home screen.

STATUS BAR

The status bar at the top of the home screen provides phone and service status information on the right side and notification alerts on the left.

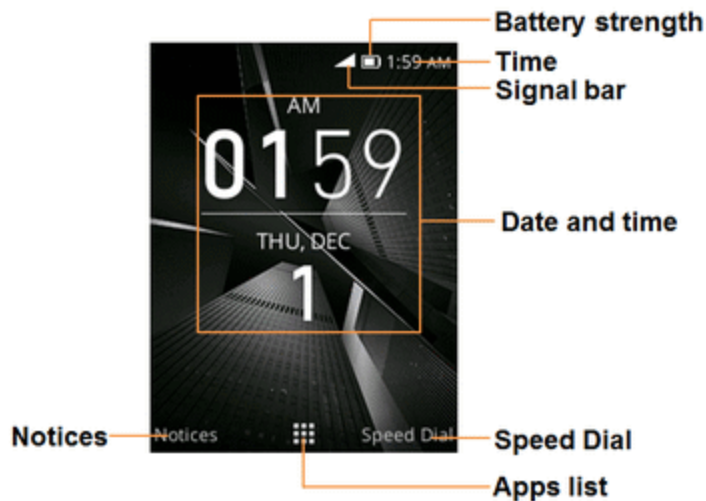

Main Status Icons

Icon	Status
	Bluetooth® active
	Wi-Fi® active
	Vibrate
	Network (full signal)
	Network (roaming)
	4G LTE data service
	3G data service
	Airplane mode
	Alarm set
	Battery (charging)
	Battery (full charge)

Notification Icons

Icon	Notification
	General numerical notifications (missed call, new mail, new message, etc.)

CHANGE THE HOME SCREEN WALLPAPER

Select and assign your phone's background wallpaper.

1. From the apps list, select **Settings**  > **Personalization** > **Display** > **Wallpaper**.

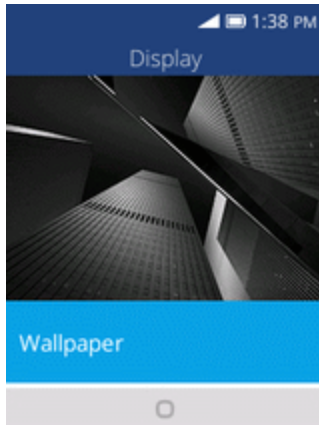

2. Select **Wallpaper** and then use the **Navigation** key to select from **Gallery**, **Wallpaper**, or **Camera**.
3. Select a wallpaper and then press the **Right soft key**  to set the wallpaper.
 - ❖ The wallpaper is set.

MAKING CONNECTIONS

The topics in this section will cover your phone's ability to help you make connections, from phone calls and maintaining contacts, to text messages, email, Internet, and international services.

PHONE CALLS AND VOICEMAIL

The following topics outline the use of your device's phone app to place and receive calls, use voicemail, and more.

PLACE AND ANSWER CALLS

The following topics describe how to directly dial calls, how to answer incoming calls, and how to use the in-call screen options.

Adjust In-Call Volume

- **Adjusting Call Volume:** Press the **Volume** key up or down during the call.

Troubleshooting

Problem: Difficulty during call.

Answer 1: It may not be possible to make a call properly in a noisy location.

Answer 2: When calling using Speaker, check the call volume. Raising the call volume may make calling difficult.

Problem: Sound pops momentarily during a call.

Answer: Are you changing location while calling? Sound pops when signal is weak and the phone switches to a different area.

Emergency Call Cautions

Emergency calls are restricted in Airplane mode.



Call Using the Phone Dialer

The most “traditional” way to place a call is by using the phone’s dialer screen.

1. From the apps list, select **Phone**  to display the phone screen.
 - ❖ The phone app opens.

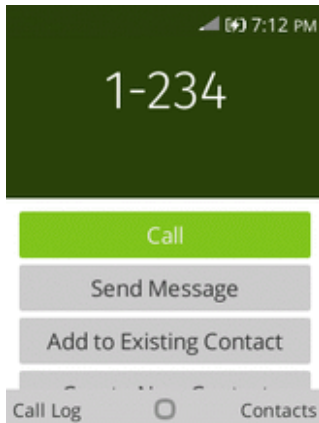
2. Press the number keys on the keypad to enter the phone number.



- As you enter digits, Smart Dial searches for contacts that match. If you see the number you want to dial, use the **Navigation** key to select the number and place the call immediately without entering the rest of the number.
3. Select  to call the number.
 - ❖ The phone dials the number. The call begins when the other party answers.
 4. To end the call, press the **End/power key** .

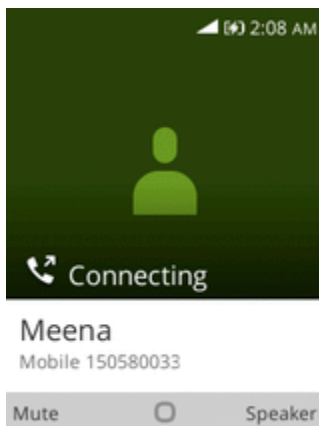

- ❖ The call ends.

Troubleshooting

Problem: Call does not connect.



Answer 1: Was the number dialed using the area code? If not, try dialing using the full 10-digit number including the area code.

Answer 2: Are you in an area with poor wireless coverage? Try calling again from another area.

Call Emergency Numbers



You can place calls to 9-1-1 even if the phone's screen is locked or your account is restricted.

To call the 9-1-1 emergency number when the phone's screen is locked with a screen lock:

1. From the lock screen, press the **Left soft key**  to enter **Emergency Call**.
2. Press the **Center soft key**  to place the call.

❖ As long as you are in an area covered by wireless service, the emergency call is placed.

To call the 9-1-1 emergency number normally or when your account is restricted:

1. Unlock the screen. For more information, see [Lock and Unlock Your Screen](#).
2. From the apps list, select **Phone**  to display the phone screen.
3. Press **9 1 1** .

❖ As long as you are in an area covered by wireless service, the emergency call is placed.

Enhanced 9-1-1 (E 9-1-1) Information

This phone features an embedded Global Positioning System (GPS) chip necessary for utilizing E 9-1-1 emergency location services where available.

When you place an emergency 9-1-1 call, the GPS feature of your phone seeks information to calculate your approximate location. Depending on several variables, including availability and access to satellite signals, it may take up to 30 seconds or more to determine and report your approximate location.

Important: Always report your location to the 9-1-1 operator when placing an emergency call. Some designated emergency call takers, known as Public Safety Answering Points (PSAPs), may not be equipped to receive GPS location information from your phone.

Answer Phone Calls

The following information lets you know how to answer incoming calls, mute the ringer on incoming calls, reject incoming calls, and more.

When you receive a phone call from a contact, the sub screen appears and displays the caller name. When you receive a phone call from someone who is not stored in Contacts, the phone number appear on the Incoming call screen.

Note: If your phone is turned off, all calls automatically go to voicemail.

Answer an Incoming Call

1. When a call arrives, press the **Right soft key**  or the **Call key**  to answer it.

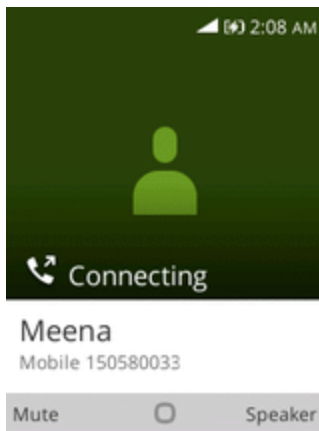

- ❖ The call begins.

2. To end the call, press the **End/power key** .

- ❖ The call ends.

Mute the Ringing Sound

To mute the ringer without rejecting the call, you can press the **Volume** key down.

Reject an Incoming Call

- When a call arrives, press the **Right soft key**  or the **End/power key**  to reject it.

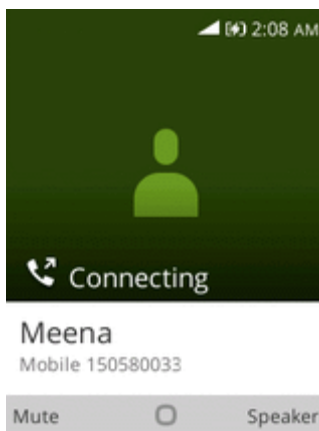



- ❖ The ringtone or vibration will stop and the call will be sent directly to voicemail.

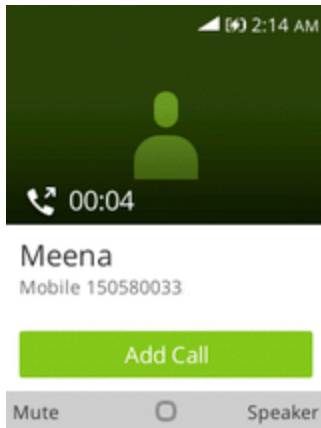

In-Call Screen Layout and Operations

While you're on a call, you will see a number of onscreen options.





- **Speaker:** Route the phone's audio through the speaker (On) or through the earpiece (Off).
 - Press the **Right soft key**  to activate **Speaker** to route the phone's audio through the speaker. (You can adjust the speaker volume using the **Volume** key.)
 - Press the **Right soft key**  again to deactivate **Speaker** to use the phone's earpiece.

Warning: Because of higher volume levels, do not place the phone near your ear during speakerphone use.

- **Mute:** Mute the microphone during an active call.
 - Press the **Left soft key**  to mute the microphone.
 - Press the **Left soft key**  again to unmute the microphone.

Note: If Mute is activated, the speaker mode is deactivated.

- **Add Call:** : Press the **Center soft key**  to initiate a conference call (3-way call).
- **End call:** Press the **End/power key**  to end the current call.

Place a Call from Contacts

You can place phone calls directly from entries in your Contacts list.

1. From the apps list, select **Contacts**  to display the contacts app.
2. Select **Contacts** to display the Contacts list.

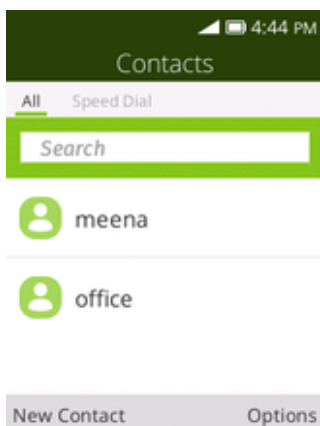

❖ The contacts list appears.

3. Use the **Navigation** key to select a contact.
4. Press the **Center soft** key  to call the number.

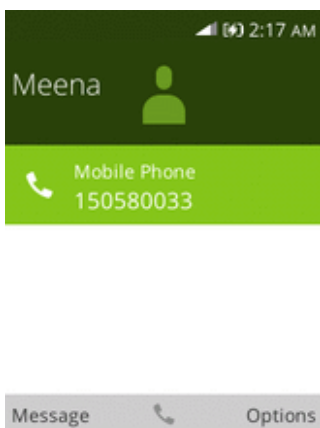

5. To end the call, press the **End/power key** .

❖ The call ends.

Call from Call Log

The call log list lets you quickly place calls to recent incoming, outgoing, or missed numbers.

1. From the apps list, press the **Call key**  to display the call log list.

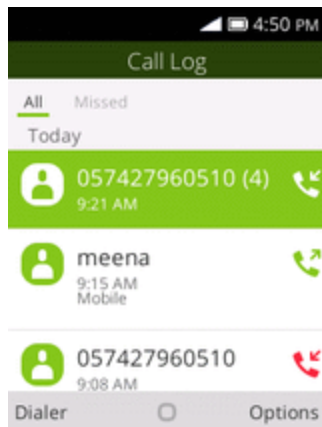

❖ The call log list appears.

2. Select an entry and press the **Right soft key**  to display the **Options** details.

3. Select an entry and press the **Center soft key**  or the **Call key**  to place a call.

❖ The phone dials the number. The call begins when the other party answers.

4. To end the call, press the **End/power key** .



❖ The call ends.

VOICEMAIL

The following topics describe how to set up and use your phone's voicemail features.

Voicemail Setup

Follow the instructions below to set up voicemail on your phone. You should set up your voicemail and personal greeting as soon as your phone is activated. Always use a passcode to protect against unauthorized access. Your phone automatically transfers all unanswered calls to your voicemail, even if your phone is in use or turned off.

1. From the apps list, select **Phone** .
2. Touch and hold  to dial your voicemail number.
3. Follow the system prompts to:
 - Create your passcode.
 - Record your name announcement.
 - Record your greeting.

Important: Voicemail Passcode – It is strongly recommended that you create a passcode when setting up your voicemail to protect against unauthorized access. Without a passcode, anyone who has access to your phone is able to access your voicemail messages.

OPTIONAL CALLING SERVICES

The following topics outline additional voice-related services available with your phone, including call services and more.

Call Waiting

When you're on a call, your phone's screen informs you that another call is coming in and displays the caller's phone number (if it is available).

To respond to an incoming call while you're on a call:

- Use the **Navigation key** to select **Answer** to answer the call or **Decline** to ignore the incoming call. (This puts the first caller on hold and answers the second call.)

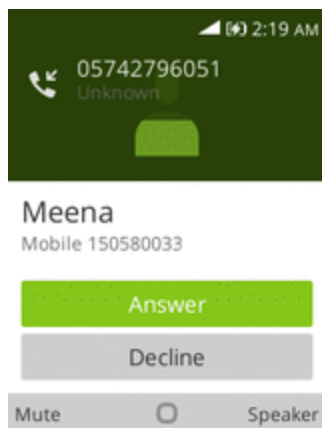

Conference Calling

With conference calling, also known as 3-way calling, you can talk to two people at the same time. When using this feature, the normal airtime rates will be charged for each of the two calls.

1. On the Phone screen, enter a number and press the **Call key**  (or place a call from Log or Contacts).

2. Once you have established the connection, dial the second number.

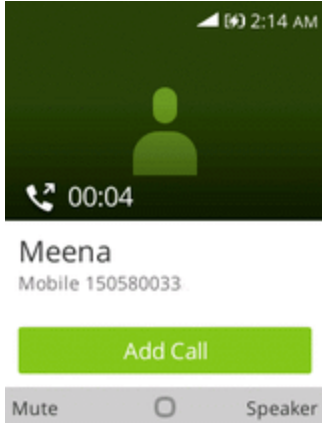

❖ This puts the first caller on hold and dials the second number.

3. When you're connected to the second party, press **Merge Call**. Your conference call is now in session.

Note: If one of the people you called hangs up during your call, you and the remaining caller stay connected. If you initiated the call and are the first to hang up, all callers are disconnected.

Call Forwarding

Call Forwarding lets you forward all your incoming calls to another phone number – even when your phone is turned off. You can continue to make calls from your phone when you have activated Call Forwarding.

Note: You are charged a higher rate for calls you have forwarded.

To activate Call Forwarding:

1. From the apps list, select **Settings**  > **Network & Connectivity** > **Call Settings** > **Call Forwarding**.

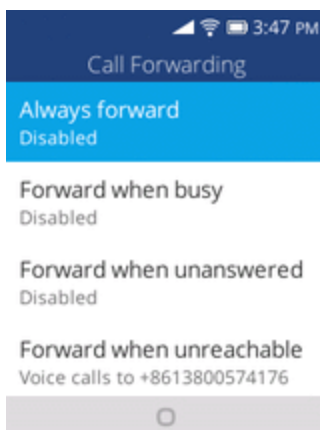

❖ The call forwarding menu appears.

2. Configure your options.

❖ Your call settings options are set.

CALL SETTINGS

Your phone's Call Settings menu lets you configure your voicemail options and a number of other settings for the phone application.

Use the Call Settings Menu

1. From the apps list, select **Settings**  > **Network & Connectivity** > **Call Settings**.

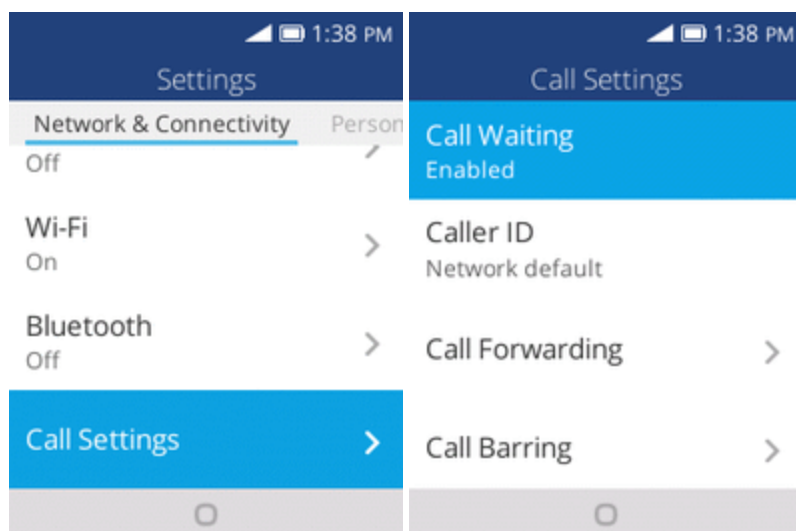

❖ The call settings menu appears.

2. Configure your options.

- Select a menu item to display its options.
- Select your options and follow the prompts to set them.

❖ Your call settings options are set.

TTY Mode

A TTY (teletypewriter, also known as a TDD or Text Telephone) is a telecommunications device that allows people who are deaf, hard of hearing, or who have speech or language disabilities, to communicate by telephone.

Your phone is compatible with select TTY devices. Please check with the manufacturer of your TTY device to ensure that it supports digital wireless transmission. Your phone and TTY device will connect using a special cable that plugs into your phone's headset jack. If this cable was not provided with your TTY device, contact your TTY device manufacturer to purchase the connector cable.

To turn TTY Mode on or off:

1. From the apps list, select **Settings**  > **Device** > **Accessibility** > **TTY**.

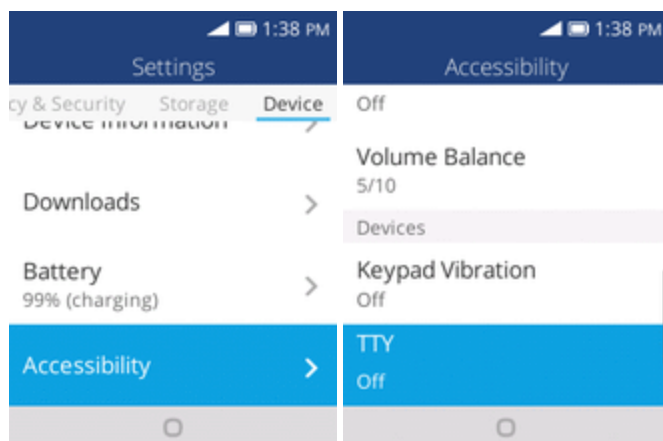

2. Select **Full**, **HCO**, or **VCO** to turn TTY mode on.

– or –

Select **Off** to turn TTY mode off.

❖ Your phone's TTY mode is set.

Note: When enabled, TTY mode may impair the audio quality of non-TTY devices connected to the headset jack.

Warning: 9-1-1 Emergency Calling

It is recommended that TTY users make emergency calls by other means, including Telecommunications Relay Services (TRS), analog cellular, and landline communications. Wireless TTY calls to 9-1-1 may be corrupted when received by public safety answering points (PSAPs), rendering some communications unintelligible. The problem encountered appears related to TTY equipment or software used by PSAPs. This matter has been brought to the attention of the FCC, and the wireless industry and the PSAP community are currently working to resolve this.

CONTACTS

The Contacts application lets you store and manage contacts from a variety of sources, including contacts you enter and save directly in your phone.

Contacts Cautions

Information saved in Contacts may be lost or changed if the battery is removed for a long period or left uncharged. Accident or malfunction may also cause loss or change to information. It is recommended that you keep a separate copy of contacts and other important information. Virgin is not responsible for any damages from lost or changed contacts.

ADD A CONTACT

You can add contacts from your phone's Phone application. Enter details such as name, phone numbers, email addresses, mailing addresses, and more.

1. From the apps list, select **Contacts** .

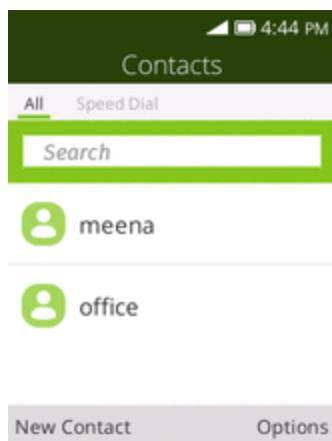

-  You will see the Contacts list.

2. Press the **Left soft key**  to add a contact.

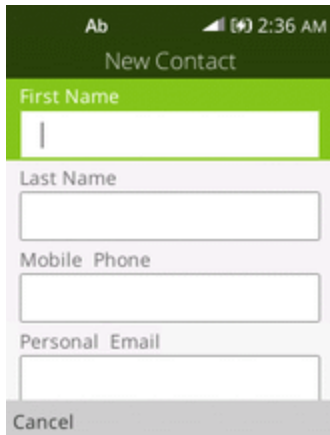

❖ The New Contact screen appears.

3. Use the keyboard to enter as much information as you want.
 - First Name
 - Last Name
 - Mobile Phone
 - Personal Email
 - Company
 - [Add Picture]: Select the Add Picture icon to assign a picture to the contact.
 - [Add Phone]: Select to add more phone numbers to the contact.
 - [Add Email]: Select to add more Email address to the contact.
 - [Add Address]: Select to add more address to the contact.
 - [Add Date]: Select to add Birthday or anniversary to the contact.
 - [Add Ringtone]: Select to add ringtone to the contact.
 - [Add Comment]: Select to add comment to the contact.
4. When you have finished adding information, press the **Right soft key**  and select **Save**.



❖ The contact is added.

Save a Phone Number

You can save a phone number to Contacts directly from the phone keypad.

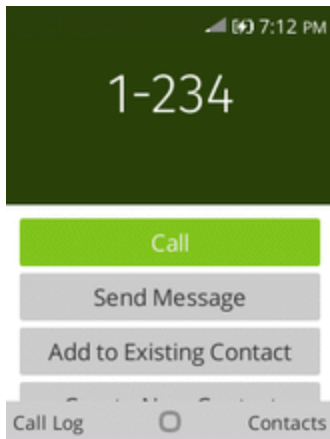
1. From the apps list, select **Phone** .
2. Enter a phone number and select **Create New Contact**.



3. To add the number to an existing contact, select **Add to Existing Contact**. To add a new contact, select **Create new contact**.
 - For an existing contact, choose the contact name and press  to select a number type for the new number.
 - For a new contact, enter the name and any additional information.
4. Press the **Right soft key**  and choose **Save**.
 - ❖ The contact is added.

VIEW CONTACTS

View a contact's details by displaying a contact entry.

1. From the apps list, select **Contacts** .

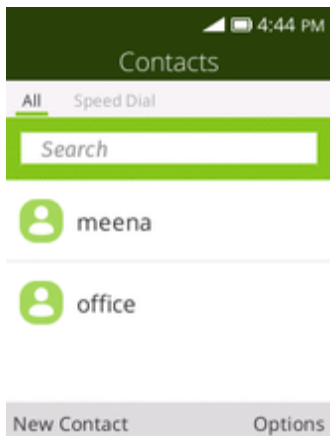

❖ You will see the Contacts list.

2. Select a contact to view its details.

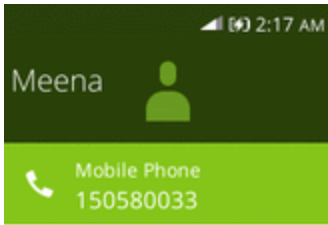

❖ The contact's detailed listing appears.

CONTACTS SCREEN LAYOUT

The following illustration show's your Contacts app layout and describes the various features.

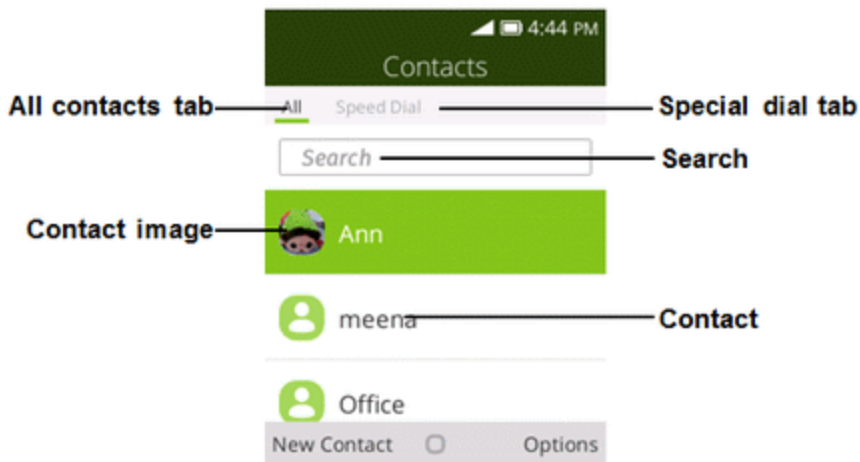



Item	Description
All contacts tab	Show all contacts.
Speed Dial tab	Show speed dial contacts.
Contact	Select to show contact's details.
Contact image	Show thumbnail of contact entry.
Search	Search contacts.

EDIT A CONTACT

Once you've added a contact, you can add or edit any of the information in the entry, assign a caller ID picture, customize with a unique ringtone, and more.

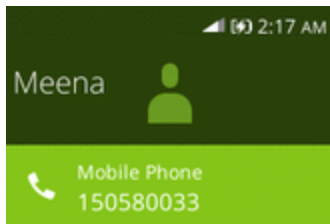
1. From the apps list, select **Contacts** .
- ❖ You will see the Contacts list.
2. Select a contact to view its details.



- ❖ The contact's detailed listing appears.
3. Press the **Right soft key**  and then select **Edit**.
 4. Add or edit the information, and then press the **Right soft key**  and select **Save**.
- ❖ Your changes are saved to the contact entry.

DELETE A CONTACT

You can delete a contact from the contacts details page.

1. From the apps list, select **Contacts** .
- ❖ You will see the Contacts list.

2. Select a contact to view its details.

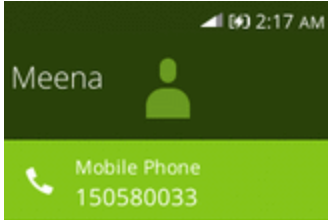

- ❖ The contact's detailed listing appears.

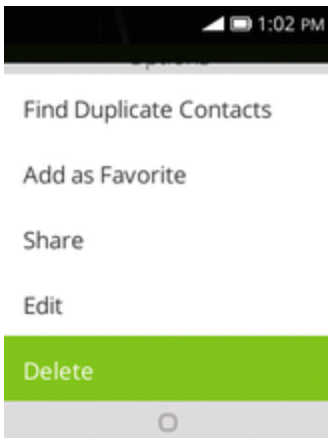

3. Press the **Right soft key**  and then select **Delete**.
4. Select **Delete**.



- ❖ The contact is deleted.

SHARE A CONTACT

You can quickly share contacts using Bluetooth, Gmail, or text messaging.

1. From the apps list, select **Contacts** .
- ❖ You will see the Contacts list.
2. Select a contact to display it, and then press the **Right soft key**  and select **Share**.
3. In the **Share With** menu, select a method:

- **E-Mail** to send the information as an Email attachment. Address the message, add a subject and a message, and then select **Send**. See [Create and Send Email](#) for details.
 - **Messages** to send the information in a text message. Select a contact or enter a wireless phone number, enter any additional information, and then select **Send**. For more information on text messaging, see [Send a Multimedia Message \(MMS\)](#).
 - **Bluetooth** to send the information via Bluetooth. See [Bluetooth](#) for information on pairing and sending via Bluetooth.
4. Complete the required steps as prompted for the selected method.
- ❖ The selected contact will be shared.



IMPORT CONTACTS

Your phone offers a couple of options for importing contacts from installed SD memory cards or external devices via USB.

Before Importing Contacts from an SD Card

You will need to have installed an SD card with previously backed up contacts information into your phone before you can import contacts. See [SD Card](#) for SD card information.

Import Contacts from an SD Card or USB Storage

1. From the apps list, select **Contacts** .
- ❖ You will see the Contacts list.
2. Press the **Right soft key**  and then select **Settings > Import Contacts/Export Contacts**.

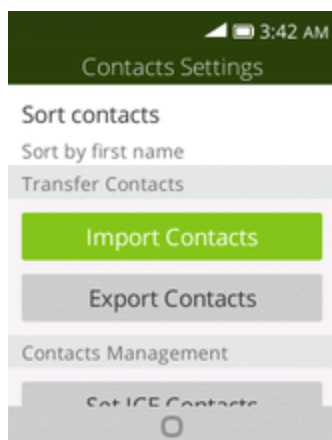

- ❖ You will see the Import Contacts/Export Contacts menu.
3. Select **Import Contacts** or **Export Contacts**.
 4. Follow the onscreen instructions to complete the import.

- ❖ The contacts are imported and stored in the selected account.

BACK UP CONTACTS

If you are saving contacts to an account that does not automatically back them up via the Cloud, you can manually back them up to an optional installed SD card for re-import if needed.

Before Backing Up Contacts to an SD Card

You will need to have installed an SD card with previously backed up contacts information into your phone before you can back up your contacts. See [SD Card](#) for SD card information.

Back Up Contacts to Your SD Card

1. From the apps list, select **Contacts** .

- ❖ You will see the Contacts list.

2. Press the **Right soft key**  > and select **Settings > Import Contacts/Export Contacts**.

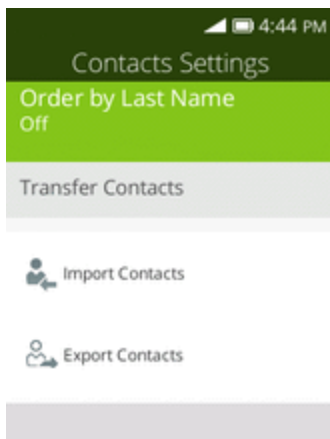

- ❖ You will see the Import Contacts/Export Contacts menu.

3. Select **Export Contacts**.
4. Select **Memory card** to confirm the export.
5. Follow the onscreen instructions and select contacts to complete the export.

- ❖ The contacts are exported and saved to the installed SD card.

MESSAGING

With wireless service and your phone's messaging capabilities, you have the opportunity to share information through many different channels and accounts, including personal and corporate email, and text and multimedia messaging.

TEXT AND MULTIMEDIA MESSAGING

With text messaging (SMS), you can send and receive instant text messages between your wireless phone and another messaging-ready phone.

Multimedia messages, or MMS, can contain text and pictures, music, audio or video files, contact cards.

See your service plan for applicable charges for messaging.

Send a Text Message

Quickly compose and send text messages on your phone.

1. From the apps list, select **Messages** .

– or –

Select  from any screen except during call.

2. On the Messages screen, press the **Left soft key**  to compose messages.

❖ The Compose screen opens.

3. Fill in one or more recipients. You can:

- Enter phone numbers directly in the **To** field. As you enter information, any matching phone numbers from your contacts list are displayed. Select a match to enter that number or address directly.
- Press the **Right soft key**  to add the contacts to whom you want to send the message.

- Select the “Message” box and then start composing your message.

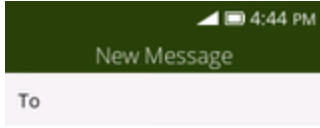

Note: Once you go over the 160-character limit, a new message is created but automatically joined into one when received.

4. When done, press the **Left soft key**  to send the text message.



Send a Multimedia Message (MMS)

When you need to add a little more to a text message, you can send a multimedia message (MMS) with text and pictures, music, audio or video files, contact cards.

1. From the apps list, select **Messages** .

– or –

Select  from any screen.



2. On the Messages screen, press the **Left soft key**  to compose messages.
3. Fill in one or more recipients. You can:
 - Enter phone numbers directly in the **To** field. As you enter information, any matching phone numbers from your contacts list are displayed. Select a match to enter that number or address directly.
 - Press the **Right soft key**  to add the contacts to whom you want to send the message.
 - Select the “Message” box and then start composing your message.

Note: To add a subject line, press the **Right soft key**  > and select **Add Subject**.



4. Select the “Message” box, and then start composing your message.
5. Press the **Right soft key**  and select **Add Attachment**.
6. In the Attach window, select from the following file attachments:

- **Video.** Select a video and attach it.
 - **Music.** Select a track from your phone or memory card.
 - **Gallery.** Select a photo from Gallery.
 - **Contacts.** Select a contact from your phone.
 - **Camera.** Select **Camera** to take a photo or a video.
7. Press the **Left soft key**  to to send the MMS message.

Save and Resume a Draft Message



While composing a text or multimedia message, press the **Right soft key**  continuously and press  to save your message as a draft.

To resume composing the message:

1. From the apps list, select **Messages** .
2. On the Messages screen, select the message to resume editing it.
3. When you finish editing the message, press the **Left soft key** .

New Messages Notification

Depending on your notification settings, the phone will play a ringtone, vibrate when you receive a new text or multimedia message.

A notice icon also appears in the notifications area of the status bar to notify you of a new text or multimedia message. When you unfold the phone, a pop-up will display to notify you the new message. Press the **Right soft key**  to reply the message directly or press the **Left soft key**  to enter home screen.

Manage Message Conversations

Text and multimedia messages that are sent to and received from a contact (or a number) are grouped into conversations or message threads in the Messages screen. Text or MMS conversations let you see exchanged messages (similar to a chat program) with a contact on the screen.

Read a Text Message

On the Messages screen, press the text message or conversation to open and read it.

To return to the Messaging screen from a conversation, press the **Back/clear key** .

Note: To view the details of a particular message, in the conversation, press the **Right soft key**  to open the options menu, and then choose **View message report**.

Note: If a message contains a link to a Web page, press the message and then press the link to open it in the Web browser.



Note: If a message contains a phone number, press the message and then press the phone number to dial the number or add it to your contacts.

View a Multimedia Message (MMS)

1. From the apps list, select **Messages** .
2. On the Messages screen, select a multimedia message or conversation to open it.
3. Select the attachment to open it.



Note: If you are concerned about the size of your data downloads, check the multimedia message size before you download it.

Reply to a Message

1. From the apps list, select **Messages** .
2. On the Messages screen, select a conversation to open it.
3. Select the Message box at the bottom of the screen, enter your reply message, and then press the **Left soft key**  to send.

Note: To reply to a text message with a multimedia message, open the text message, press the **Right soft key**  and then select **Add Subject** or **Add Attachment**. The text message is automatically converted into a multimedia message.



Delete Conversations

1. From the apps list, select **Messages** .
2. On the Messages screen, press the **Right soft key**  to select **Delete Thread** to delete the conversation.
3. To delete more than one conversation, select **Select Thread** and then press the **Right soft key**  to delete these messages.

Tip: You can also delete a conversation while you're viewing it. While viewing a conversation, press the **Right soft key**  and then select **Delete** to confirm.

Text and MMS Options

The messages settings menu lets you control options for your text and MMS messages including message limits, size settings, and notifications.

1. From the apps list, select **Messages** .
2. On the Messages screen, press the **Right soft key**  and select **Settings**. You can set the following:

- **Auto Retrieve Messages:** Select this option to automatically retrieve all your multimedia messages completely. When selected, the multimedia message header plus the message body and attachments will automatically download to your phone. If you turn off, only the multimedia message header will be retrieved and shown in your Messaging screen.
- **WAP Push:** Press to enter WAP push options.
- **Emergency alerts:** Press to enter Emergency alerts options.

E-MAIL

Use the E-Mail application to send and receive email from your webmail or other accounts, using POP3 or IMAP, or access your Exchange ActiveSync account for your corporate email needs.

Set Up an E-mail Account

Your phone supports several types of email accounts and allows you to have multiple email accounts set up at one time.

Before setting up an email account, make sure you have the username (user ID), password, server name, etc., so you can get set up successfully.

1. From the apps list, select **E-Mail** .
 - ❖ A popup window for adding an account appears if no email account has been previously set up.
2. Follow the onscreen instructions to set up your email account.
 - ❖ The email account is set up and you will begin receiving email.

Add Another E-mail Account

If you have multiple email accounts you wish to view on your phone, you can add several types of personal email accounts, such as POP3 and IMAP accounts on your phone.

1. From the apps list, select **E-Mail** .

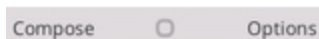
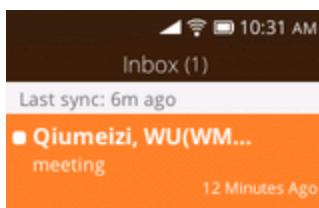

- ❖ The email inbox opens.

2. Press the **Right soft key**  and select **Settings**. Then press the **Left soft key**  to add account.

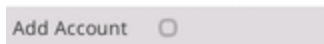
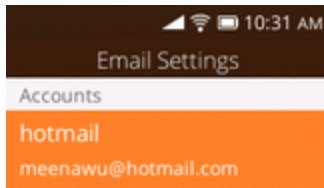

3. Follow the onscreen instructions to complete the account setup.
 - ❖ The email account is added and you will begin receiving email for the account.

Create and Send E-mail

Compose and send email using any account you have set up on your phone. Increase your productivity by attaching files such as pictures, videos, or documents to your email messages.

1. From the apps list, select **E-Mail** .

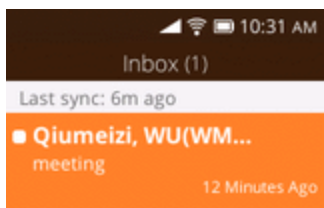

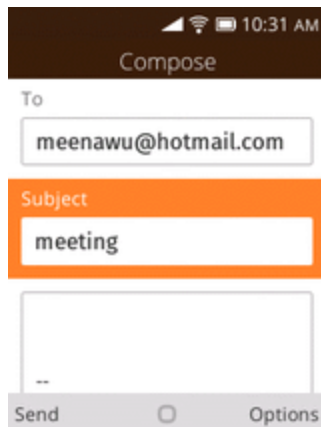

- ❖ The email inbox opens.

- From the inbox, press the **Left soft key**  to compose.



- ❖ The email composition window opens.
- Enter the message recipient(s), subject, and message, and then press the **Left soft key**  to send.
- ❖ The email message is sent.

Email Composition Options

- **Add Cc/Bcc:** In the mail subject or composition box, press the **Right soft key**  to add recipients.
- **Add Attachment:** In the mail composition box, press the **Right soft key**  > **Add Attachment**. Locate and then choose the picture or video you want to attach.
- **Save to Local Draft (Send Later):** While composing your message, press the **End/power key**  and a pop-up window will display whether to save as a draft.

Note: To view your draft email messages, in the inbox, press the **Right soft key**  > **View Folders > Local Drafts**.

Note: To view your sent messages, in the inbox, press the **Right soft key**  > **Outbox**.

Open E-mail Messages

You can also open and read email messages directly from the email inbox. Reading and replying to email on your phone is as simple as on your computer.

1. From the apps list, select **E-Mail** .

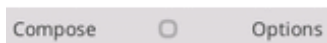
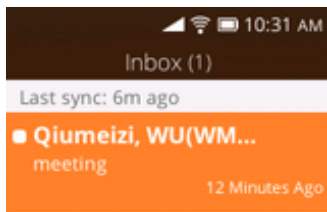

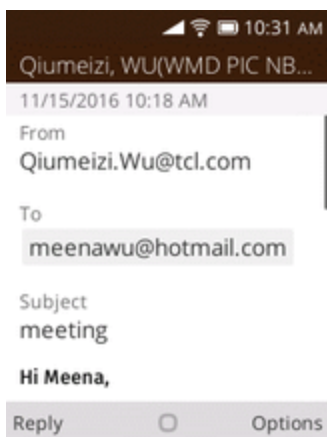

❖ The email inbox opens.

2. Press the message you want to view.



❖ The email message opens.

3. Press the **Left soft key**  to reply email directly or press the **Right soft key**  to open email options to reply to the message.

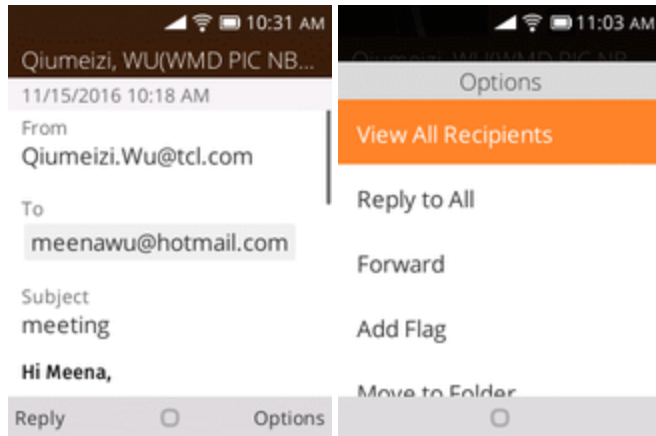



Delete an E-mail Account

You can delete an email account from your phone if you no longer wish to receive messages for the account on your phone.

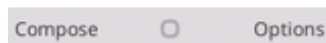
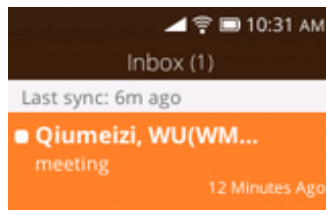
1. From the apps list, select **E-Mail** .



- ❖ The email inbox opens.

2. Press the **Right soft key**  > **Settings**.
3. Select the account(s) to delete, and then press the **Left soft key**  to confirm.

- ❖ The account is deleted from your phone

Manage Your Email Inbox

Your email inbox provides management options for viewing, sorting, and deleting your email messages.

View Your Email Inbox

1. From the apps list, select **E-Mail** .

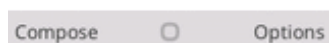
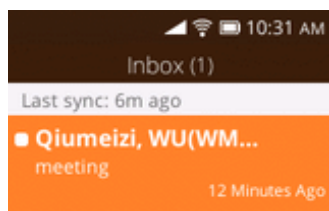

❖ The email inbox opens.

2. Press the **Right soft key**  > **View Folders** > **Inbox** to see all your email inboxes at once.

Refresh an Email Account



Whatever your automatic synchronization settings are, you can also synchronize your sent and received email messages manually at any time.

- While viewing the account you want to synchronize, press the **Right soft key**  > **Synchronize**.

Delete an Email Message

- Choose the message you want to delete, press the **Right soft key**  > **Delete**.

Delete Multiple Email Messages





1. On the email account inbox, press the **Right soft key**  > **Edit** > **Select Multiple**.
2. Select the messages you want to delete.
3. Press the **Right soft key**  > **Delete**, and then press the **Right soft key**  to confirm.

INTERNET

The following topics describe how to connect to and use the Internet on your phone.

Data Connection Status and Indicators

Your phone displays the current status of your data connection through indicators at the top of the screen. The following symbols are used:

Icon	Status
	Network (full signal): The fullness of the triangle icon indicates the strength of the signal. A fuller icon means a better signal.
	4G LTE data service: Your phone is connected to a 4G LTE network.
	3G data service: Your phone is connected to a 3G data network.
	Wi-Fi connection: Your phone is connected to a Wi-Fi network for data.

BROWSER

Your phone's Web browser gives you full access to both mobile and traditional websites on the go, using 2G, 3G, 4G, or Wi-Fi data connections.

SSL/TLS

SSL (Secure Sockets Layer) and TLS (Transport Layer Security) are protocols for encrypting sent/received data. While in a screen connected by SSL/TLS, data is encrypted to safely send/receive private information, credit card numbers, corporate secrets, etc., and provide protection against online threats (eavesdropping, falsification, impersonation, etc.).

SSL/TLS Cautions

When opening a secured page, users must decide as their responsibility whether or not to open the page with use of SSL/TLS. Virgin and the applicable Certification Authorities make no guarantees whatsoever to users regarding security of SSL/TLS.

Use the Browser

Your phone supports the Web browser for surfing on the Internet.

1. From the apps list, select **Browser** .

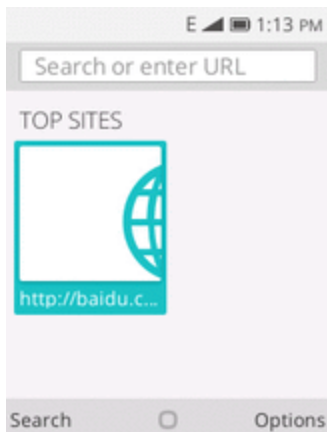

❖ Browser opens.

2. Press the **Left soft key**  to enter search words or a Web address (URL).

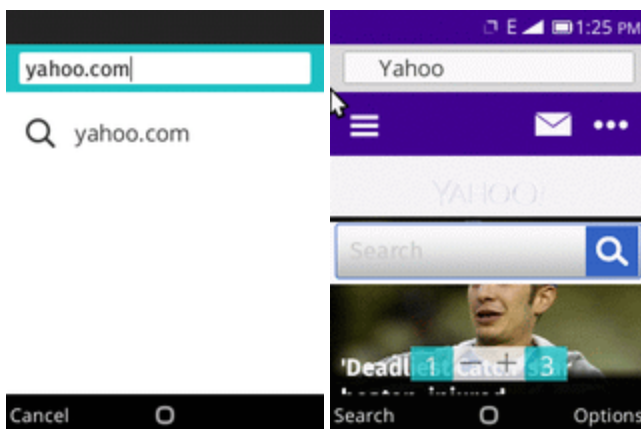

❖ The search results appear or a Web page opens.

3. Use the **Navigation** key to locate the place you want to visit, and then press  to confirm.

Browser Options

Customize your experience with the Internet through the browser options menu.

1. From the apps list, select **Browser** .

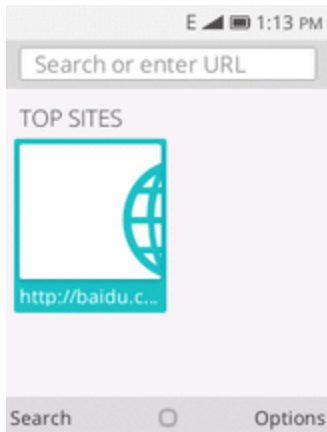

❖ The browser opens.

2. Press the **Right soft key**  to open browser **options**.

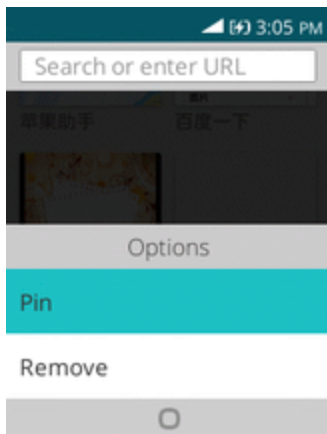

❖ Your browser options are displayed.

CONNECTIVITY

The following topics address your phone's connectivity options, including Wi-Fi and Bluetooth.

WI-FI

Wi-Fi provides wireless Internet access over distances of up to 300 feet. To use your phone's Wi-Fi, you need access to a wireless access point or "hotspot."





The availability and range of the Wi-Fi signal depends on a number of factors, including infrastructure and other objects through which the signal passes.

Turn Wi-Fi On and Connect to a Wireless Network

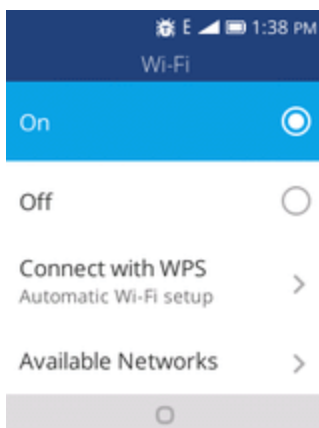
Use the wireless and networks setting menu to enable your phone's Wi-Fi and connect to an available Wi-Fi network.

1. From the apps list, select **Settings**  > **Network & Connectivity** > **Wi-Fi**.



- ❖ The Wi-Fi settings menu appears.
2. Select the **On** icon to turn Wi-Fi on .
 - ❖ Wi-Fi is enabled. You will see the names and security settings of in-range Wi-Fi networks.
 - To disable Wi-Fi, select the **Off** icon .
 3. Choose **Available Networks**, select a Wi-Fi network to connect, enter the password (if it's not an open network), and then press the **Right soft key**  to connect.
 - ❖ Your phone is connected to the Wi-Fi network. You will see () in the status bar.
 - The password, for a household wireless LAN router, is sometimes found on a sticker on the router (WEP, WPA, KEY, etc.). Contact the router manufacturer for information. For password for a public wireless LAN, check with user's service provider.
 - Entering a password is not required if an access point is not security protected.

Note: The next time your phone connects to a previously accessed secured wireless network, you will not be prompted to enter the password again, unless you reset your phone to its factory default settings or you instruct the phone to forget the network.

Note: Wi-Fi networks are self-discoverable, which means no additional steps are required for your phone to connect to a Wi-Fi network. It may be necessary to provide a user name and password for certain closed wireless networks.

Wi-Fi Settings

Use the Wi-Fi settings menu to manually set your Wi-Fi connection options.

1. From the apps list, select **Settings**  > **Network & Connectivity** > **Wi-Fi**.

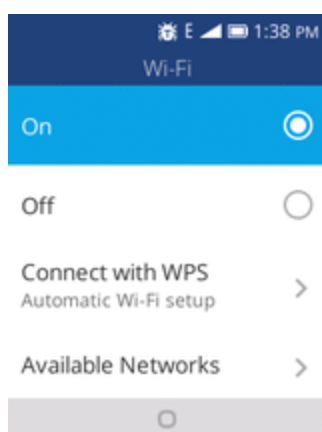

❖ The Wi-Fi settings menu appears.

2. Select the **On** icon to turn Wi-Fi on .

❖ Wi-Fi is enabled. You will see the names and security settings of in-range Wi-Fi networks.

- To disable Wi-Fi, select the **Off** icon .

3. Select **Advanced Settings**.

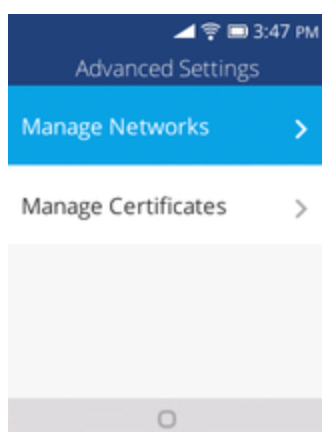

- ❖ The advanced Wi-Fi settings menu appears.

Disconnect Wi-Fi

You may wish to disconnect from a connected Wi-Fi network without turning Wi-Fi off.

1. From the apps list, select **Settings**  > **Network & Connectivity** > **Wi-Fi**.



- ❖ The Wi-Fi settings menu appears.
2. Select **Available Networks** and choose the name of the connected access point and then press the **Right soft key**  to forget.
- ❖ Wi-Fi is disconnected.

Note: After disconnecting from an access point, you may need to re-enter the password to reconnect.

BLUETOOTH

Bluetooth® is a short-range communications technology that allows you to connect wirelessly to a number of Bluetooth devices, such as headsets and hands-free car kits, and Bluetooth-enabled handhelds, computers, printers, and wireless phones. The Bluetooth communication range is usually approximately 30 feet.

Bluetooth Hints

Problem: Can't use Bluetooth?

Answer: Is your phone in airplane mode? Bluetooth is unavailable in airplane mode.

Bluetooth Function Cautions

Information may not appear correctly on connected devices depending on the transferred data.

Bluetooth Information

Bluetooth is a technology that enables wireless connection with PCs, Bluetooth devices with hands-free features, etc.

Function	Description
Audio output	Listen to music, etc., wirelessly.
Hands-free calls	Call hands-free, using Bluetooth-capable hands-free devices and headsets.
Data exchange	Exchange data with Bluetooth devices.

Enable the Bluetooth Feature

Use the settings menu to enable or disable your phone's Bluetooth capabilities.

- Wireless connection to all Bluetooth functions is not guaranteed for the phone.
- The phone may not connect properly depending on the other device.
- Noise may be experienced with wireless calls and hands-free calls depending on the conditions.

To enable Bluetooth:

1. From the apps list, select **Settings**  > **Network & Connectivity** > **Bluetooth**.

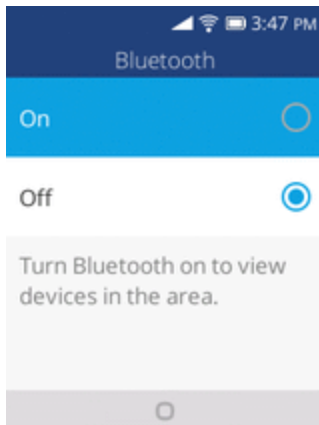

- ❖ The Bluetooth settings open.

2. Select the **On** icon to turn Bluetooth on .

- ❖ Bluetooth is enabled.

- To disable Bluetooth, select the **Off** icon .

Note: Turn off Bluetooth when not in use to conserve battery power, or in places where using a wireless phone is prohibited, such as aboard an aircraft and in hospitals.

Pair Bluetooth Devices

Search for and pair nearby Bluetooth devices. Registered Bluetooth® devices can be connected simply.

- Enable the Bluetooth function on the Bluetooth devices being paired beforehand.

To pair Bluetooth devices:

1. From the apps list, select **Settings**  > **Network & Connectivity** > **Bluetooth**.

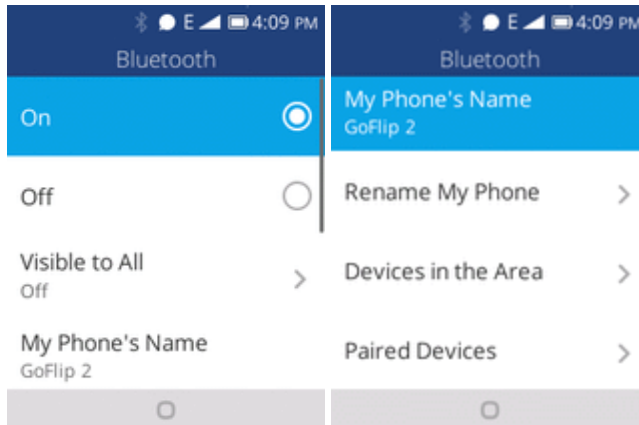

- ❖ The Bluetooth settings open.
 - Nearby devices appear in the “Devices in the Area” list.
 - If a target device is not detected, press the **Right soft key**  to rescan.
- 2. Select a device from the “Devices in the Area” list, and follow the onscreen instructions to pair with the device.
 - ❖ The Bluetooth device is paired to your phone.
 - Methods to accept a Bluetooth connection differ depending on the devices used.

Unpairing from a Paired Device

1. From the Bluetooth settings menu, select **Paired Devices** to unpair.

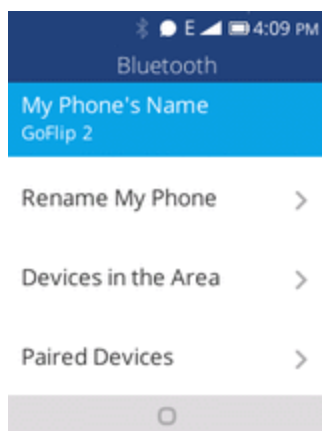

2. Press the **Right soft key**  to forget.

- ❖ The device is unpaired from your phone. To make another connection with the device, you will need to pair again.

Connect to a Paired Bluetooth Device

You can listen to music over a Bluetooth stereo headset, or have hands-free conversations using a compatible Bluetooth headset or car kit. It's the same procedure to set up stereo audio and hands-free devices.

1. From the apps list, select **Settings**  > **Network & Connectivity** > **Bluetooth**.

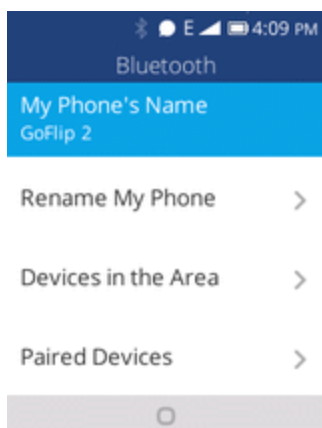

- ❖ The Bluetooth settings open.
 - Paired Bluetooth devices appear in the “Paired Devices” list.

2. Select a device from the “Paired Devices” list.

- ❖ Your phone connects to the paired device.

The pairing and connection status is displayed below the device's name in the Bluetooth devices section. When the device is connected to your phone, the Bluetooth paired icon  is displayed in the status bar. Depending on the type of device you have connected, you can then start using the headset or car kit to listen to music or make and receive phone calls.

Note: Due to different specifications and features of other Bluetooth-compatible devices, display and operations may be different, and functions such as transfer or exchange may not be possible with all Bluetooth-compatible devices.

Send Information Using Bluetooth

You can use Bluetooth to transfer information between your phone and another Bluetooth-enabled device such as a phone or notebook computer.

Types of Data You Can Send via Bluetooth

You can send the following types of information, depending on the device you are sending to:

- Images and videos
- Contacts
- Audio files

In the instructions below, Contacts data is being used as an example.

Sending Contacts Data via Bluetooth

1. From the apps list, select **Contacts** .

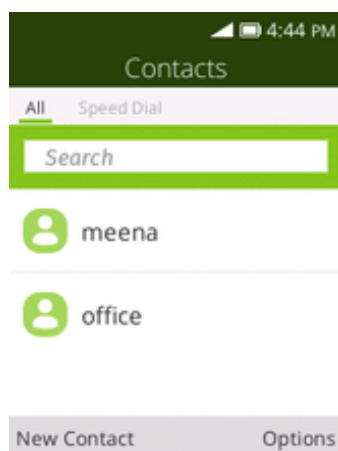

-  You will see the Contacts list.

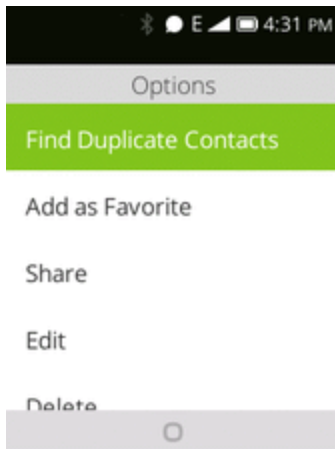

2. Select a contact to send.
3. Press the **Right soft key**  > **Share** > **Bluetooth**.



4. Select a paired device to receive the data.
 - ❖ The contact information is sent.
 - If you see a message to confirm, follow the onscreen instructions.

Receive Information via Bluetooth

Your phone is capable of receiving a wide variety of file types with Bluetooth, including pictures, music tracks, and documents such as PDFs.

1. When another device attempts to send a file to your phone via Bluetooth, you will see a request to accept the file.
2. Press the **Left soft key**  on home screen to review this notice, and press the **Right soft key**  to accept the file.
 - ❖ The file is sent to your phone.
 - When your phone receives a file, you will see a notification.
 - When you open a received file, what happens next depends on the file type:
 - Media files and documents are usually opened directly in a compatible application. For example, if you open a music track, it starts playing in the Music application.
 - For a vCard contact file, if there are multiple vCard files on your storage card, you can choose to import one, several, or all of those contacts to your contacts list.

APPS AND ENTERTAINMENT

The topics in this section will explore the features that make your phone so much more than a phone, from the camera and productivity apps to music, entertainment, and more.



CAMERA AND VIDEO

You can use the camera or video camera to take and share pictures and videos. Your phone comes with a 2 megapixel camera that lets you capture sharp pictures and videos.

CAMERA OVERVIEW

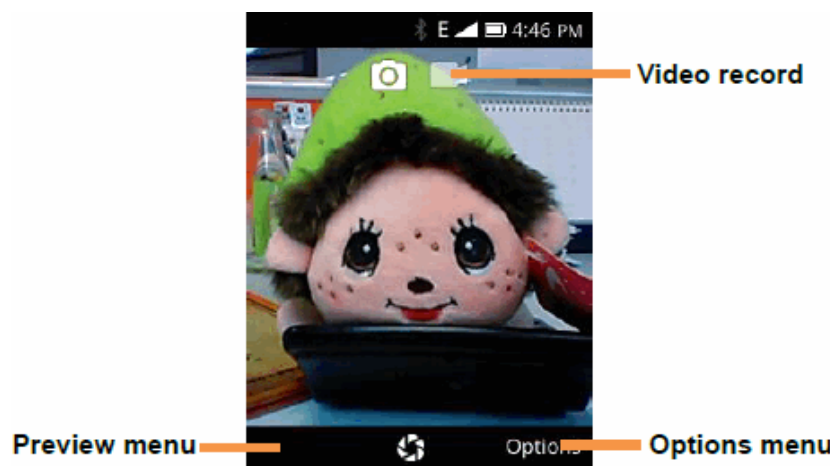
The camera's viewfinder screen lets you view your subject and access camera controls and options.



- **Options:** Press the **Right soft key**  to open settings options.
- **Preview:** Press the **Left soft key**  to view picture you took.
- **Video record:** Select to start/pause video record.

Learn More About Your Phone's Camera

For an overview of your phone's camera and its features, you can access more information through the phone's settings menu.

- From the apps list, select Camera .



❖ The camera viewfinder appears.

TAKE PICTURES AND RECORD VIDEOS

The following topics teach you how to take pictures and record videos with your phone's camera.

Capturing Pictures/Videos

- **File Format for Pictures:** File format for pictures is JPEG.
- **File Format for Videos:** File format for videos is 3GPP.

! Camera Cautions

If Lens Becomes Dirty: Fingerprints/smudges on lens prevent capturing of clear still images/videos. Wipe lens with a soft cloth beforehand.

Avoid Exposure to Direct Sunlight: Be careful not to expose lens to direct sunlight for long periods. May discolor color filter and affect color of images.

Take a Picture

You can take high-resolution pictures using your phone's camera.

Note: If you have an SD card installed, pictures and videos are stored to the SD card. If no card is installed, pictures and videos are saved to your phone's memory.

1. From the apps list, select **Camera** .



❖ The camera viewfinder appears.

2. Press  to take the picture.

❖ The shutter clicks and the picture is captured and saved to your phone or SD card.

Record Videos

You can record high-quality videos with your phone's video camera.

Note: If you have an SD card installed, pictures and videos are stored to the SD card. If no card is installed, pictures and videos are saved to your phone's memory.

1. From the apps list, select **Camera** .



❖ The camera viewfinder appears.

2. Aim the camera at your subject and then press **Navigation Right** key to switch to **Video** , and press **OK** to start recording.

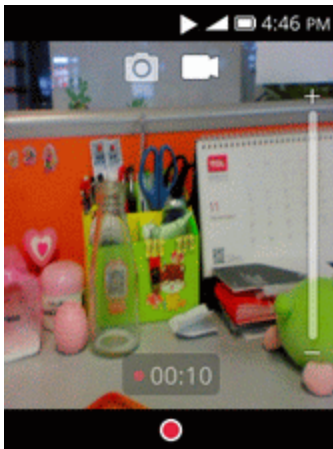

❖ Video recording begins.

3. Press **OK** again to stop recording.

❖ The camera stops recording and the video is captured and saved to your phone or SD card.

VIEW PICTURES AND VIDEOS USING GALLERY

Using the Gallery application, you can view pictures that you've taken with your phone's camera, downloaded, or copied onto your storage card or phone memory.

For pictures that are on your storage card or phone memory, you can do basic editing such as rotating and cropping. You can also easily assign a picture as your contact picture or wallpaper and share pictures with your friends.

View Pictures and Videos

You can access and view all your stored pictures from your phone's Gallery.



1. From the apps list, select **Gallery** .



- ❖ The list of pictures opens.

2. Select an image to view the picture.



- ❖ The picture opens.
 - Press the **Left soft key**  to zoom in or zoom out.
 - Press the **Right soft key**  to open options menu and choose what to do with the picture.

Pictures and Videos: Review Screen

After capturing a picture or video, from the camera screen, press the **Left soft key**  to see the item in the review screen. From there, you can access options such as view, share, set as wallpaper or delete the picture.

EDIT PICTURES

Whether you're browsing pictures in filmstrip or grid view in the Gallery application, you can choose a picture to open a selection menu and choose to delete the picture, rotate or crop it, and more.

Rotate a Picture

1. From the apps list, select **Gallery** .



- ❖ The list of pictures opens.

2. Select the picture you want to rotate.
3. Press the **Right soft key**  and then select **Rotate**.

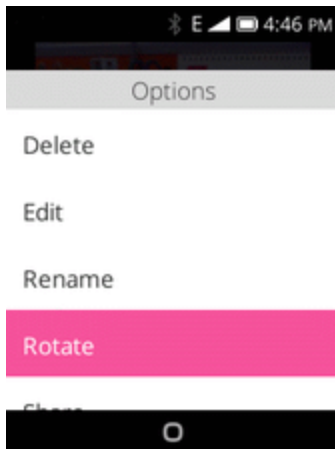

❖ The picture is rotated.

Edit a Picture

1. From the apps list, select **Gallery** .

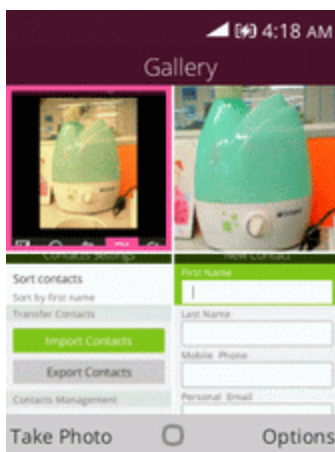

❖ The list of pictures opens.

2. Select the picture you want to edit.
3. Press the **Right soft key**  and then select **Edit**.

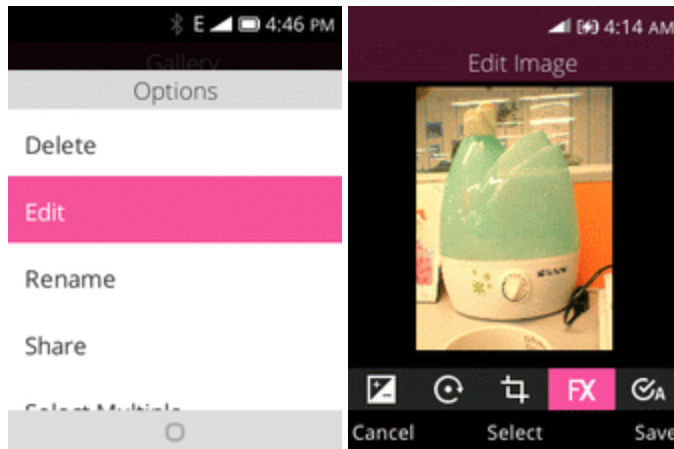

❖ An edit screen appears on the picture.

- Exposure
- Rotate
- Crop
- Filters
- Auto-correction

4. Press the **Right soft key**  to save the changes to the picture.

❖ The modified picture is saved in the album as a copy. The original picture remains unedited.

SHARE PICTURES AND VIDEOS

The Gallery application lets you send pictures using email, Bluetooth or multimedia messages.



Send Pictures or Videos by Email, Messages or Bluetooth

You can send several pictures, videos, or both in an email message. They are added as file attachments in your email.

1. From the apps list, select **Gallery** .



❖ The list of pictures opens.

2. Select the pictures you want to share.
 - To select multiple items, press the **Right soft key**  > **Select Multiple** to turn on multiple select. Select all the items you want to include.
3. Press the **Right soft key**  > **Share** and then on the Share via menu, select **E-mail** or **Bluetooth**.

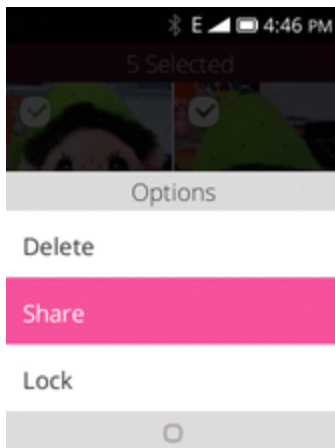

❖ Follow onscreen prompts to complete and send the message.

Note: If you selected **E-mail** and you have multiple email accounts, the default email account will be used.

For more information, see [Create and Send Email](#), [Send a Multimedia Message \(MMS\)](#), and [Bluetooth](#).

CAMERA SETTINGS

You can adjust your camera's settings by pressing the **Right soft key**  on the camera screen.

Switch Between Camera and Video Mode

You can switch between camera and video mode freely.

1. From the apps list, select **Camera** .



- ❖ The camera viewfinder appears.

2. Press **Navigation Right** key to switch to **Video**.

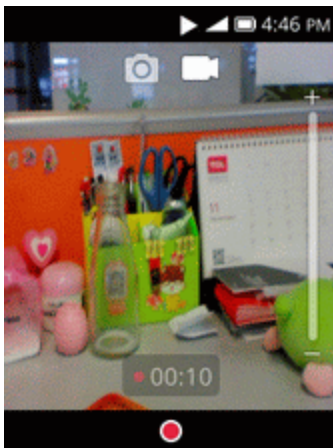

- ❖ The video screen opens.

Set Camera Functions

You can configure your camera's settings to fit any situation and event.

1. From the apps list, select **Camera** .



- ❖ The camera viewfinder appears.

2. Press the **Right soft key**  to open options menu.

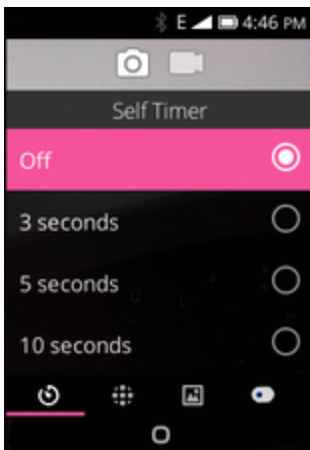

- ❖ The camera settings menu opens.

3. Select your desired settings.

- ❖ The settings are applied.

- Settable items differ depending on the camera type in use.



PRODUCTIVITY

Use your phone to stay ahead of the game with calendar, alarm, calculator and more productivity apps.

CALENDAR

Use Calendar to create and manage events, meetings, and appointments. Your Calendar helps organize your time and reminds you of important events. Depending on your synchronization settings, your phone's Calendar stays in sync with your Calendar on the Web, Exchange ActiveSync calendar, and Outlook calendar.

Calendar Operations

- **View Today's Calendar:** From the Calendar, press the **Right soft key**  > **Today**.
- **Change Calendar View:** From the Calendar, press the **Right soft key**  and choose **Weekly View** or **Day View** to change the current view.
- **View Particular Day/Month/Year:** From the Calendar, press the **Right soft key**  > **Go** and press **Navigation** key to choose particular day, month or year.

Add an Event to the Calendar

Add events to your calendar directly from the Calendar application.

1. From the apps list, select **Calendar** .



- ❖ The Calendar app opens.

2. Press the **Left soft key**  to add new event.

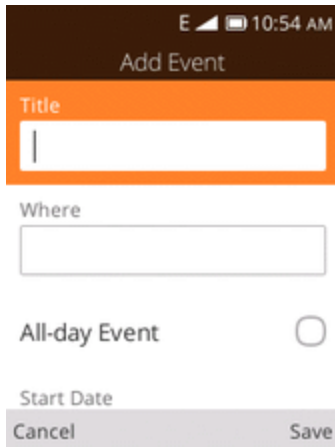

- ❖ The add event window opens.

3. Enter an event title, start date/time, end date/time, etc., and then press the **Right soft key**  to save.

- ❖ The event is added to your calendar.

View Calendar Events

You can display the Calendar in daily, weekly or monthly view.

1. From the apps list, select **Calendar** .



- ❖ The Calendar app opens.

2. Select a date and then press **OK** to display events.

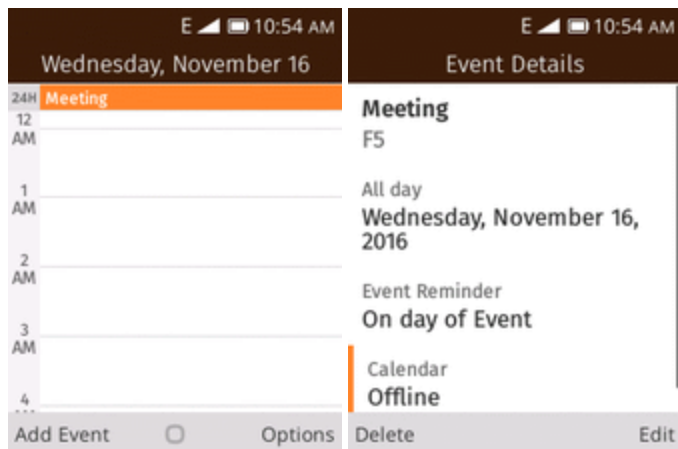

- ❖ The event details appear.
 - In event details, press the **Right soft key** to edit the event.
 - In event details, press the **Left soft key** to delete the event.

Sync Calendars

You can select which calendars you'd like to sync on your phone, along with what types of information you want to sync.

1. From the apps list, select **Calendar** .



- ❖ The Calendar app opens.

2. Press the **Right soft key**  > **Sync calendar**.

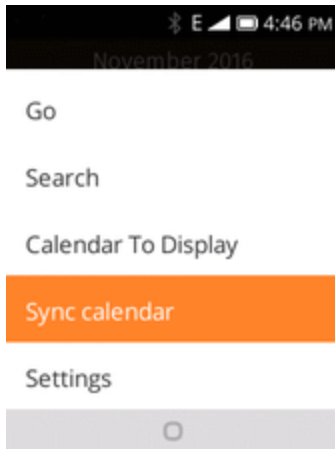

- ❖ The sync settings have been updated.

CALCULATOR

Your phone's convenient built-in calculator lets you perform basic mathematical equations.

1. From the apps list, select **Calculator** .



- ❖ The calculator app launches.
2. Press keys for calculations.
- ❖ Calculation results appear.

CLOCK

Your phone has a clock app that lets you set alarms, use a stopwatch, and set a timer.

Check the Time

You can check the phone any time on your phone. The current time displays in the center of the home screen.

Set Alarms

Set multiple alarms using your phone's Clock app.

1. From the apps list, select **Clock** .

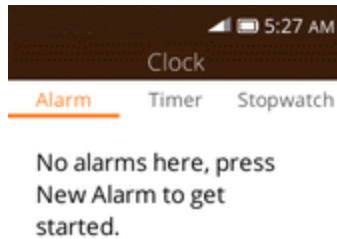

- ❖ The Clock appears.

2. Press the **Left soft key**  to create new alarm.

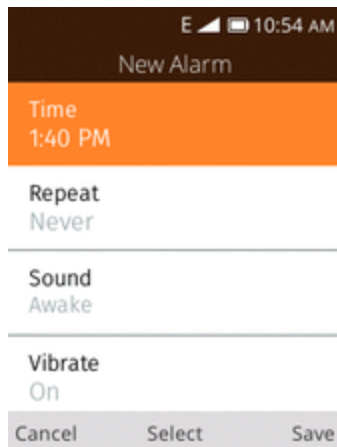



- ❖ The alarm adding screen appears.

3. Set the alarm options, including time, repeat pattern, alarm tone, and volume, and then press the **Right soft key**  to confirm.

- ❖ The alarm is set.

Phone at Alarm Time

- At the set alarm time, the phone sounds the alarm and/or vibrates.
- Stopping an alarm: When the alarm sounds, press the **Left soft key**  to snooze it or the **Right soft key**  to stop.

Additional Clock Features

Your phone's clock app provides additional useful features including stopwatch and timer functions. These features are available from the clock app display.

- From the apps list, select **Clock** .

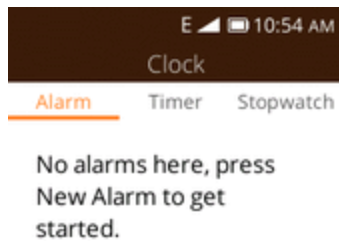



New Alarm Turn On Options

- ❖ The Clock appears.



Timer

The stopwatch lets you time events down to the hundredth of a second.

1. From the clock app, press **Navigation** key to enter **Timer** screen.
2. Set the time and press  to begin timing
3. Press  to stop timing.

Stopwatch

The timer provides a countdown timer for up to 99 hours, 59 minutes, and 59 seconds.

1. From the clock app, press **Navigation** key to enter **Stopwatch** screen.
2. Press  to begin timing.
3. Press the **Right soft key**  to record lap.

4. Press  to stop or resume timing.

- Additional options include Lap to keep track of laps, Restart to continue timing, and Reset to reset the stopwatch to zero.

ENTERTAINMENT AND ACTIVITIES

The following topics provide an overview of your phone's music.

Play Music

Use the Music app to listen to all your music on your phone. Compatible music file formats include: mp3, wma, wav, mod, etc.

1. From the apps list, select **Music** .

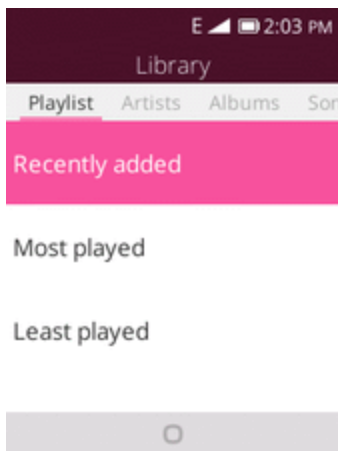

❖ The Music app opens.

2. Use the **Navigation** key to select a library category such as Artist or Albums.
3. Choose an item from the category window and then select a song.

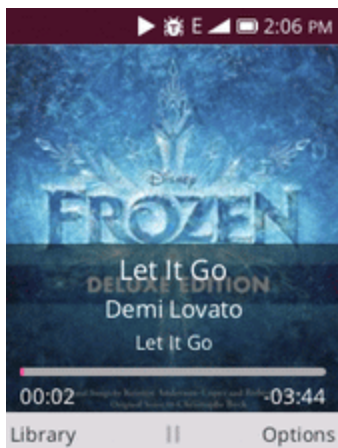

❖ The song begins playing.

Music Screen Layout

The following picture outlines the main features of the Music app player screen.



Options Menu:

Feature	Description
Shuffle All	Select to shuffle all songs.
Repeat All	Select to repeat all songs
Share	Select to share a song via E-Mail, Messages or Bluetooth.
Set as ringtone	Select to set as ringtone of the phone.

SETTINGS

The topics in this section will cover your phone's settings menus and options. For an overview of the settings menu, see [Basic Settings](#).

CONNECTIONS SETTINGS

The following topics introduce your phone's basic settings menus and cover your phone's Connections settings options.

BASIC SETTINGS

From the app screen, select **Settings**  to access your phone's settings menu.

The table below outlines the top-level settings categories.

Category	Description
Airplane Mode	Enable and set airplane mode options.
Cellular & Data	Set your phone's cellular network settings.
Geolocation	Select your phone's location access options.
Wi-Fi	Enable and set Wi-Fi options.
Bluetooth	Enable Bluetooth connections.
Call Settings	Set caller ID, call forwarding options, etc.
Messaging Settings	Set messaging ringer, messaging vibrate, etc.
Internet Sharing	Enable Wi-Fi hotspot options.
Emergency Alert	Set Emergency alert options.
Sound	Set ringtone, operation tones, etc.
Display	Set wallpaper, brightness, etc.
Search	Set search engine and enable search suggestions.
Notices	Enable notices on lock screen options.
Date & Time	Set date and time of the phone.
Language	Set your phone's language.
Input Methods	Select and configure speech input settings.
Answer Mode	Select device answer mode.
Screen Lock	Set your phone's lock screen options.
SIM Security	Set your SIM Card security.
App Permissions	Check and manage the apps in your phone.
Do Not Track	Set Do Not Track mode options.
Browsing Privacy	Set browsing privacy options.
USB Storage	Enable USB storage.
End user storage	Check application storage status.

Category	Description
Device Information	Access important phone information and view legal and safety information.
Downloads	Check downloads on your phone.
Battery	Monitor your phone's battery usage.
Accessibility	Set accessibility options such as invert colors, hearing aid compatibility, etc.
Developer	Set developer options.
System Updates	Check and update your phone with the latest version.
KaiOS Account	Set your KaiOS account.
Anti-Theft	Set your device anti-theft information. For more information, visit https://services.kaiotech.com/antitheft
Operator Services	Check your operator services.

Access Settings

- From the apps list, select **Settings** .

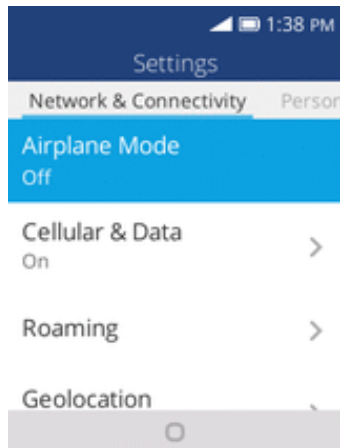

❖ The settings menu opens.

- Select categories and then select your settings options.

❖ Settings are made and applied.



WI-FI SETTINGS MENU

The Wi-Fi settings menu lets you turn Wi-Fi on or off, set up and connect to available Wi-Fi networks, and configure advanced Wi-Fi options.

For more information about Wi-Fi settings, see [Wi-Fi](#).

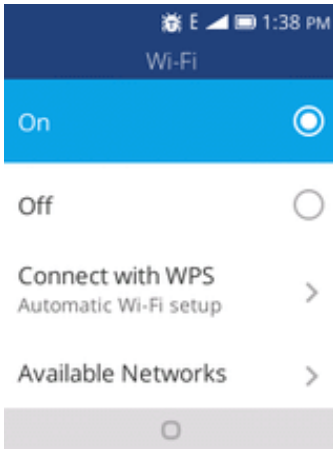
1. From the apps list, select **Settings**  > **Network & Connectivity** > **Wi-Fi**.



- ❖ The Wi-Fi settings menu appears.
2. Select the **On** icon  to turn Wi-Fi on.
 - ❖ Wi-Fi is enabled. You will see the names and security settings of in-range Wi-Fi networks.
 - To disable Wi-Fi, select the **Off** icon .
 3. Select a Wi-Fi network, enter the password, and press the **Right soft key**  to connect.
 - ❖ Your phone is connected to the selected Wi-Fi network.
 4. Configure your Wi-Fi settings.

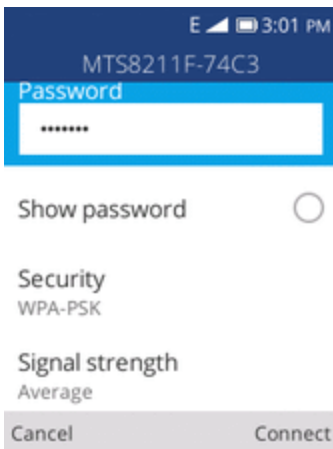

- ❖ Your Wi-Fi settings changes are saved.
 - The password, for a household wireless LAN router, is sometimes found on a sticker on the router (WEP, WPA, KEY, etc.). Contact the router manufacturer for information. For

password for a public wireless LAN, check with user's service provider.

- Entering a password is not required if an access point is not security protected.

Advanced Wi-Fi Settings

The advanced Wi-Fi settings menu lets you set up and manage wireless access points.

- **Manager Networks:** From Wi-Fi settings, select **Advanced Settings > Manage Networks**.
- **Import certificates:** From Wi-Fi settings, select **Advanced Settings > Manage Certificates**.

BLUETOOTH SETTINGS



Your phone's Bluetooth® capabilities let you use wireless headsets, send and receive pictures and files, and more. For details on your phone's Bluetooth usage, see [Bluetooth](#).

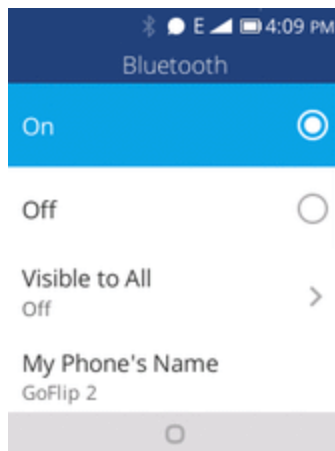

- From the apps list, select **Settings**  > **Network & Connectivity > Bluetooth**.



- ❖ The Bluetooth settings open.

Bluetooth Settings Operations

- **Enable Bluetooth:** Select the **On** icon  to turn Bluetooth on.
 - When enabled, confirmation appears for your phone to be discoverable by other devices. Follow the onscreen instructions.
 - To disable Bluetooth, select the **Off** icon .
- **Visible to All:** Select the the **On** or **Off** icon to enable this function.
 - When enabled, your phone can be discovered by other devices.
 - This setting is available when Bluetooth is enabled.
- **My Phone's Name:** Check your phone's current name.

- **Rename My Phone:** You can set the phone's name as it appears to other device.
 - Emoji cannot be used in a device name.
 - This setting is available when Bluetooth is enabled.
- **Nearby Devices:** Check available devices for connecting.
 - If the target device does not appear, press the **Right soft key**  to search again.
 - This setting is available when Bluetooth is enabled.
- **Paired Devices:** Make sure the other devices are set to be discovered. From Bluetooth settings, select the device name in "Devices in the Area" and follow the onscreen instructions.
 - Depending on the device, you may be required to enter or accept a passkey.
 - If the target device does not appear, press the **Right soft key**  to search again.
 - This setting is available when Bluetooth is enabled.

CELLULAR AND DATA

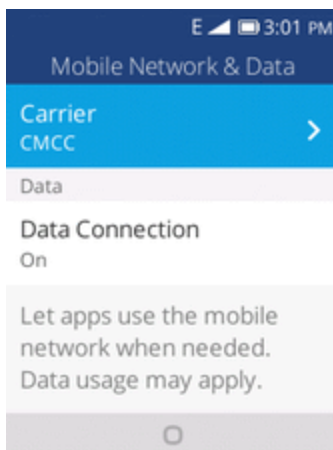

The mobile network & data menu lets you view your SIM card's carrier, enable data connection, enable VoLTE, and more.

- From the apps list, select **Settings**  > **Network & Connectivity** > **Cellular & Data**.



- ❖ The Cellular & Data window opens.

Cellular & Data Operations

- **Carrier:** Check your SIM card's carrier.
- **Data Connection:** Select the **On** icon  to enable data connection.
 - To disable data connection, select the **Off** icon .

- **APN Settings:** Set APN settings options.

PERSONALIZATION SETTINGS

The following topics outline the device settings options available on your phone, including sounds, display, notices, and more.

SOUND SETTINGS

The sound settings menu lets you control your phone's audio, from ringtones and alerts to tap tones and notifications.

Sound Settings Overview

The sound settings menu allows you to configure the following options:

Sound Setting	Description
Volume	Set volume for ringtones, alarms, and media.
Tones	Set your phone's default ringtone, alerts tone and manage tones options.
Other Sounds	Set sounds for dial pad, camera and sending message.

Access Sound Settings

1. From the apps list, select **Settings**  > **Personalization** > **Sound**.

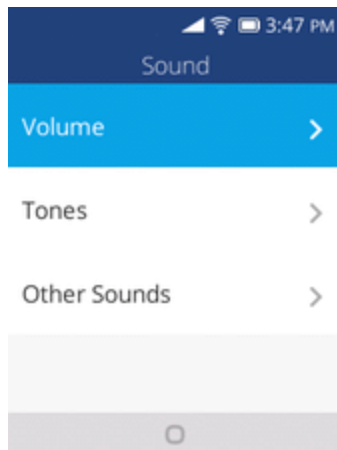

- ❖ The sound window opens.

2. Set your sound options.

- ❖ Your sound settings are saved and applied.

DISPLAY SETTINGS

Use the phone's display settings menu to adjust items such as wallpaper, brightness, and screen timeout.

Display Settings Overview

The display settings menu allows you to configure the following options:

Display Setting	Description
Wallpaper	Set a wallpaper.
Brightness	Set the display brightness.
Screen Timeout	Set screen timeout duration. Note: Longer durations discharge the battery more quickly.

Access Display Settings

1. From the apps list, select **Settings**  > **Personalization** > **Display**.

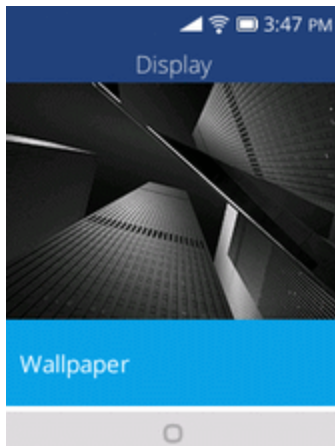

- ❖ The display window opens.

2. Set your display options.

- ❖ Your display settings are saved and applied.

SEARCH SETTINGS

The search settings menu lets you manage search engine and enable search suggestions.

Search Settings Overview

The search settings menu allows you to configure the following options:

Search Setting	Description
Search Engine	Set your phone's search engine.
Search Suggestions	Set to enable search suggestions.

Access Search Settings

1. From the apps list, select **Settings**  > **Personalization** > **Search**.

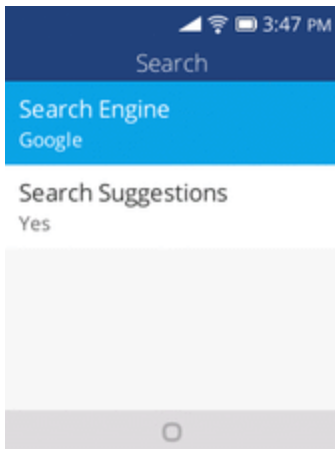

❖ The search window opens.

2. Set your search options.

❖ Your search settings are saved and applied.

NOTICES SETTINGS

The notices settings menu lets you enable notices show on lock screen or after reboot.

Notices Settings Overview

The notices settings menu allows you to configure the following options:

Notices Setting	Description
Show on lock screen	Set to enable notices show on lock screen.
Show after reboot	Set to enable notices show after reboot.

Access Notices Settings

1. From the apps list, select **Settings**  > **Personalization** > **Notices**.

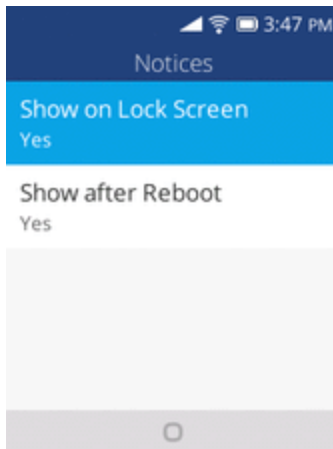

❖ The notices window opens.

2. Set your notices options.

❖ Your notices settings are saved and applied.

DATE AND TIME SETTINGS

Use the date and time settings menu to set date and time manually, as well as select time format options.

Date and Time Overview

The following date and time options may be configured:

Date & Time Option	Description
Date	Set the date manually.
Time	Set the time manually.
Region	Set the time region.
City	Set the time city.
Time format	Select 12-hour or 24-hour format.

Access Date & Time Options

1. From the apps list, select **Settings**  > **Personalization** > **Date & Time**.

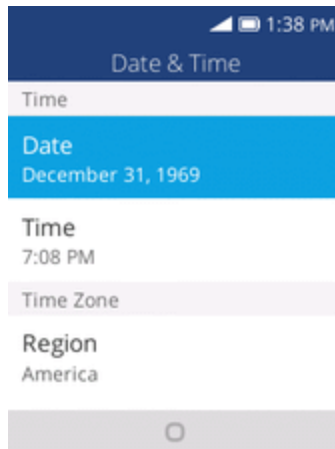

- ❖ The date & time window opens.
2. Set available date and time options.
 - ❖ Your date and time settings are applied and saved.

LANGUAGE SETTINGS

Your phone's language settings let you select a language for the phone's menus and keyboards.

Language Settings Overview

You can set the following options in the Language settings menu:

Language Setting	Description
Language	Set the language for your display and menus.
Sample Format	Check language sample format.

Access Language Setting Options

1. From the apps list, select **Settings**  > **Personalization** > **Language**.

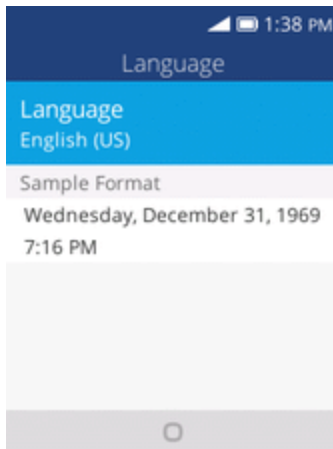

- ❖ The Language settings menu opens.

2. Set options.

- ❖ The language settings are applied and saved.

INPUT METHODS SETTINGS

Your phone's input settings let you select and configure keyboard settings, and set your phone's input languages.

Input Methods Settings Overview

You can set the following options in input methods settings menu:

Input Methods Setting	Description
Use T9	Set to enable T9 input methods.
Select Input languages	Set the input language.

Access Input Languages Setting Options

1. From the apps list, select **Settings**  > **Personalization** > **Input Method**.

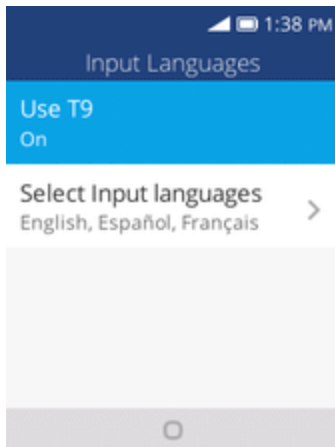

- ❖ The input settings menu opens.
2. Set options.
 - ❖ The input settings are applied and saved.

PRIVACY AND SECURITY SETTINGS





The following topics cover your phone's privacy & security settings, including screen lock settings, app permissions, Do Not Track, and browsing privacy.

SCREEN LOCK SETTINGS

You can increase the security of your phone by creating a screen lock. When enabled, you have to enter the correct password to unlock the phone's control buttons and screen.

Important: To protect your phone and data from unauthorized access, it is recommended that you use the Password protection. It is also recommended you frequently change your password to ensure the safety of your phone and personal data.

Access Screen Lock Options

1. From the apps list, select **Settings**  > **Privacy & Security** > **Screen Lock**.
 - ❖ The screen lock settings menu opens.
2. Select the **On** icon  to enable data connection. To disable data connection, select the **Off**  icon.
3. Enter and re-enter your passcode, and press the **Right soft key**  to save the setting.



- ❖ The screen lock are applied and saved.

APP PERMISSION SETTINGS

Set installed applications' permissions.

App Permissions Settings Overview

Items that can be checked in the App permissions settings menu are the following.

App Permissions Setting	Description
Camera	Set the camera's geolocation permission.
System	Set the system's geolocation permission.

Access App Permissions Settings

1. From the apps list, select **Settings**  > **Privacy & Security** > **App Permissions**.

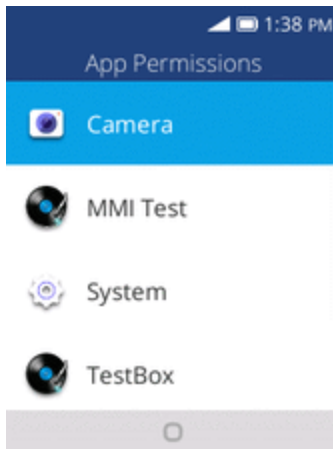

2. Set options.
 - ❖ The app permissions settings are applied and saved.

DO NOT TRACK SETTINGS

Set your preference for Do Not Track.

Access Do Not Track Settings

1. From the apps list, select **Settings**  > **Privacy & Security** > **Do Not Track**.

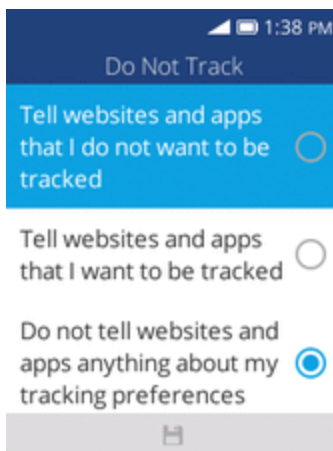

2. Select options.

- ❖ The do not track settings are applied and saved.

BROWSING PRIVACY SETTINGS

Set your browsing privacy settings.

Access Browsing Privacy Settings

1. From the apps list, select **Settings**  > **Privacy & Security** > **Browsing Privacy**.

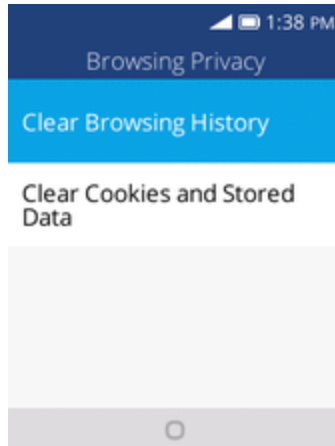

2. Select options.

- ❖ The browsing privacy settings are applied and saved.

STORAGE SETTINGS

The storage settings menu lets you manage internal storage on your phone and provides menu choices for an optional SD card (not included).

USB STORAGE SETTINGS

The following topics address your phone's connectivity options, including USB file transfer, Wi-Fi, Bluetooth, and more.

1. From the apps list, select **Settings**  > **Storage** > **USB Storage**.

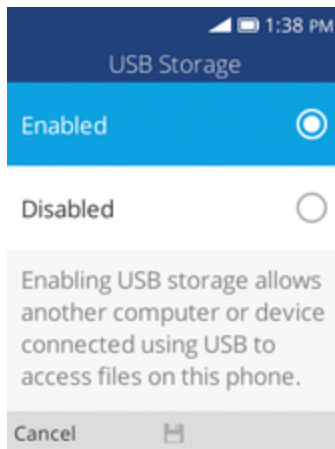

- ❖ The USB storage settings menu opens.

2. Select the **Enable** icon  to enable USB storage. To disable, select the **Disable** icon .

MEDIA STORAGE SETTINGS

View the total space/free space of media files in your phone memory and in an optional installed SD card.

1. From the apps list, select **Settings**  > **Storage** > **Media Storage**.

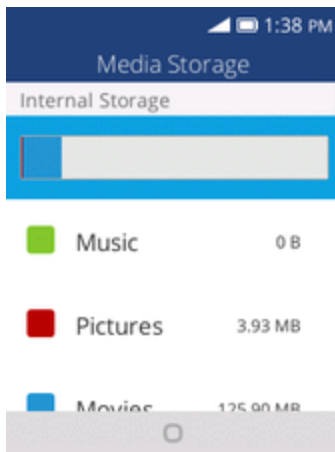

- ❖ The media storage window opens.

DEVICE SETTINGS

The following topics including device information, downloads, battery, accessibility, etc.

DEVICE INFORMATION SETTINGS

The device information menu lets you access important phone information, and view legal and safety information.

Device Information Overview

The following device information items may be reviewed or set:

Device Information Item	Description
Phone Number	Check your phone number.
Model	Check the phone's model.
Software version	Check the phone's software version.
Hardware	Check the phone's hardware version.
More Information	Check more information about your phone: <ul style="list-style-type: none">■ OS Version■ Hardware Revision■ IP Address■ Platform Version■ Bluetooth Address■ MAC Address■ MEID■ IMEI■ IMSI■ ICCID■ Build Number
Legal information	Check Health & Safety information, open source notices, etc.
Factory Reset	Reset all settings and delete all data on phone.

Tip: Before performing a factory data reset on your phone, you may want to unmount an installed SD memory card to avoid losing any data you may have stored on it.

Access Device Information Options

1. From the apps list, select **Settings**  > **Device** > **Device Information**.



❖ The device information window opens.

2. Select or view available options.

❖ Your phone information is displayed.

DOWNLOADS SETTINGS

You can check your downloaded file in Downloads.

Access Device Information Options

1. From the apps list, select **Settings**  > **Device** > **Downloads**.

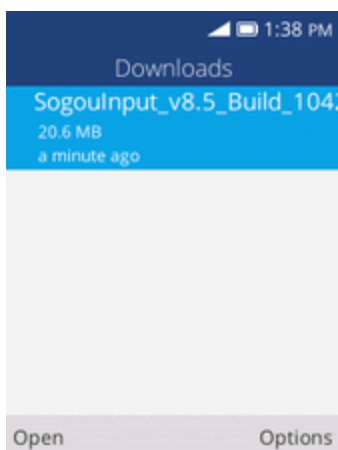

❖ The downloads window opens.

BATTERY SETTINGS

Monitor your phone's battery usage through this settings menu. Check the battery consumption and percentage.

1. From the apps list, select **Settings**  > **Device** > **Battery**.

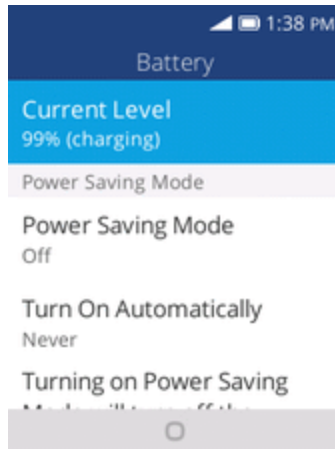

- ❖ The Battery window opens.
2. Select items to view details.
 - ❖ Check your battery condition and access additional options.

ACCESSIBILITY SETTINGS

The accessibility menu lets you enable and manage accessibility-related applications.

Accessibility Settings Overview

The following accessibility options may be configured:

Accessibility Option	Description
Invert Colors	Set color inversion (may affect performance).
Backlight	Set to enable backlight.
Large text	Set to enlarge the screen text.
Captions	Set to enable captions settings.
Readout Mode	Set to enable readout mode.
Mono Audio	Set to enable mono audio.
Volume Balance	Set volume balance.
Keypad Vibration	Set to enable keypad vibration.
TTY	Select to enable TTY mode.

Accessibility Option	Description
Hearing Aid Compatibility (HAC)	Set to enable hearing aid compatibility.

Access Accessibility Options

1. From the apps list, select **Settings**  > **Device** > **Accessibility**.

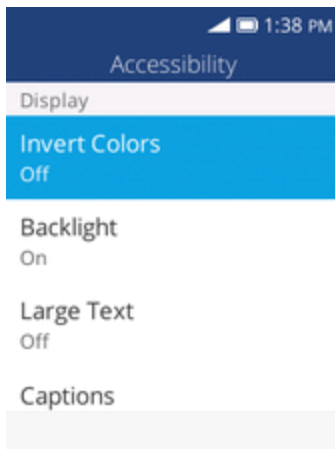

- ❖ The accessibility settings menu opens.

2. Set available accessibility options.

- ❖ Your accessibility settings are applied and saved.

SYSTEM UPDATES SETTINGS

From time to time, updates may become available for your phone. You can download and apply updates through the **Settings** > **System Updates** menu.

System Updates Settings Overview

The following system updates options may be configured:

Accessibility Option	Description
UICC Unlock	Set to unlock UICC.
Update PRL	Set to update PRL.
Update Profile	Set to update profile.
Update Firmware	Set to update firmware.

Access Accessibility Options

1. From the apps list, select **Settings**  > **Device** > **System Updates**.

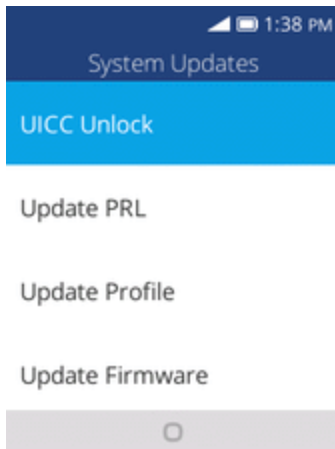

- ❖ The system updates window opens.
2. Select the item you want to update.
 - ❖ Your phone will update automatically.

GETTING HELP

The topics in this section will cover troubleshooting tips, phone specifications, and how to contact Virgin and manage your wireless service.

FOR ASSISTANCE

The following topics address areas of support for your phone, including troubleshooting, specifications, account information, warranty information, and customer service contact information.

TROUBLESHOOTING

Check the questions and answers below for troubleshooting solutions for common phone issues.

Check Here First

Problem: Phone freezes/operation is unstable.

Answer: Turn the phone on again. If you are unable to turn the phone off, remove and replace the Battery, and then turn the phone on again. Data that was being edited is erased after your phone is powered on again.

Problem: Cannot use phone, mail, or Internet.

Answer 1: Check whether you are where signal is weak or out of service area.

Answer 2: Power the phone on again.

Answer 3: Is the phone in Airplane mode? To check that Airplane mode is canceled:

- From the apps list, select **Settings**  > **Network & Connectivity** > **Airplane Mode**.

Answer 4: Is data communication disabled? To check that data communication is enabled:

- From the apps list, select **Settings**  > **Network & Connectivity** > **Mobile network & Data** > **Data Connection**.

Problem: Battery level goes down quickly.

Answer: Are you where signal is weak or have been out of service area for a long period? Calling where signal is weak or being out of service area uses a lot of Battery.

Problem: Cannot unlock screen.

Answer: Power the phone on again. If you are unable to turn the phone off, remove and replace the Battery, and then power the phone on again. Data that was being edited is erased after the phone is powered on again.

SPECIFICATIONS

The following tables list your phone's and battery's specifications.

Phone Specifications

Item	Description
Weight	Battery installed: Approx. 118 g
Continuous Talk Time	GSM: Approx. 6 hours 3G: Approx. 8 hours
Continuous Standby Time	Approx. 280 hours
Charging Time	Approx. 3 hours
Dimensions	Approx. 105x 52.8 x18.7 mm

Battery Specifications

Item	Description
Type	Hardpack
Capacity	1350 mAh

VIRGIN ACCOUNT INFORMATION AND HELP

Find out about managing your account online and on your phone, buying additional minutes for your plan, and getting help.

For more information about your Virgin account, as well as other Virgin services, visit us at: Virginmobileusa.com.

Manage Your Account

Access information about your account. You can:

- Check your minutes.
- Re-Virgin[®] (add money to your account).
- Changes plans.
- And more

From Your Phone

Access account information and other self-service tools from Virgin Zone.

- From home, select **Virgin Zone** .

You can also dial directly for access to certain information:

- Dial #225 (**#BAL**) to check account balance.
- Dial #233 (**#ADD**) to make a payment.
- Dial #611 to launch Virgin Zone or call Virgin Customer Care (depending on your Settings) to get answers to other questions.

From Your Computer

- Log in with your phone number and account PIN at Virginmobileusa.com.

From Any Other Phone

- Virgin Customer Care: **1-888-VIRGIN-4U** (1-888-266-7848).

Re-Virgin

Virgin Mobile makes it easy to add money to your account. You decide exactly how and where you want to pay. Keep your account active by using your phone and adding money to your account.

Pay with Cash

Find an Authorized Re-Virgin Retailer near you. Pick up a Re-Virgin Card or recharge for as low as \$10 at the register, where available.

Pay Anytime with a Credit/Debit Card

Dial #233 (**#ADD**) to add money from your phone or visit **My Account** at Virginmobileusa.com to do it online. Securely register your credit/debit card with Virgin for more convenient one-time payments or to set up easy Auto Re-Virgin payments.

Set Up Worry-Free Payments with Auto Re-VirginSM

It's the easiest way to make sure your account stays on and active. Use a credit card, debit card or bank account—whatever's best for you.

Visit Virginmobileusa.com/reVirgin to get the details on all your Re-Virgin options.

COPYRIGHT INFORMATION

©2017 Virgin Worldwide, Inc. All rights reserved. Other marks are the property of their respective owners.

INDEX

3
3-way Calling 34

A
Accessibility Settings 108
Accessory Jack 4
Activation and Service 13
Airplane Mode 18
Alarm 82
Answer a Call 30
App Permission Settings 101
Applications 16
 Launch 16
Apps
 List 17

B
Back Key 4
Basic Operations 15
Battery
 Charge 6
 Insert 4
 Remove 5
 Settings 108
Battery Use 4
Bluetooth 61
 Connect 64
 Information 62
 Pair Devices 63
 Receive information 66
 Send information 65
 Settings 91
 Turn on or off 62
Brightness 95
Browser 56
 Options 57
 Use 56
Browsing Privacy Settings 103

C
Calculator 81
Calendar 78
 Add event 78
 Sync 80

 View events 79
Call Forwarding 35
Call Log
 Make call from 32
Call Settings 36
Call Waiting 34
Camera
 Set Functions 76
 Settings 76
 Switch between camera and video
 mode 76
 Take a picture 69
 Viewfinder 68
Camera and Video 68
Capture Screenshots 16
Car Kit
 Connect 64
Charger/Accessory Jack 4
Clock 81
 Additional Features 83
 Alarm 82
 Stopwatch 83
 Timer 83
Conference Calling 34
Connections Settings 88
Connectivity 59
Contacts 38
 Add contact 38
 Back Up 45
 Delete 42
 Edit 42
 Import 44
 Make call from 31
 Save a phone number 39
 Share 43
 View 40

D
Data Services
 Status indicators 56
Data Usage Settings 92
Date and Time 97
Device Information Settings 106
Device Settings 106
Display Settings 95

Do Not Track Settings 102
Downloads Settings 107

E

E-mail 50
 Add Another Account 50
 Delete account 54
 Send Gmail 51
 Set Up Account 50
 View and reply 52

Email
 Manage inbox 54
 Share pictures 74

Emergency Numbers 29
Enhanced 9-1-1 (E 9-1-1) 29
Enter Text 19
Entertainment and Activities 85

F

For Assistance 112

G

Gallery 71
 View pictures and videos 71
Gmail
 Send message 51
 Share pictures 74

H

Headset
 Connect 64
Headset Jack 4
Home Screen 23
 Customize 24
 Layout 23
Home Screen and Apps List 15

I

Import Contacts 44
In-Call Screen Layout and Operations 30
Incoming Call
 Answer 30
 Reject 30
Input Settings 98-99
Internet 56

L

Language 98-99
Language Settings 98-99

M

Manage Your Account 113
Media Storage Settings 104
Memory 96
Messaging 46
MMS
 Options 49
 Send messages 47

N

Notices Settings 96
Notification Icons 24
Notifications 24

O

Optional Calling Services 34

P

Parts and Functions 3
Personalization Settings 94
Phone
 Dialer 27
Phone Calls
 Answer 29
 Emergency numbers 29
 Using Call Log 32
 Using contacts 31
 Using phone keypad 27
Phone Calls and Voicemail 27
Phone Layout (illustration) 3
Phone Number 18
 Save to contacts 39
Phone Settings Menu 15
Phone Status 106
Phone Update 20
 PRL 22
 Profile 21
 Software 20
Pictures
 Crop 73
 Edit 72
 Rotate 72
 Share via email 74

- Take with camera 69
- View 71
- Place and Answer Calls 27
- Play Music 85
- Power Off 12
- Power On 12
- Privacy and Security Settings 101
- PRL Update 22
- Productivity 78

R

- Re-Virgin 114
- Reject Incoming Call 30
- Ringtone 94

S

- Save a Phone Number 39
- Screen Lock Settings 101
- Screen Timeout 95
- SD Card 9
 - Insert 10
 - Remove 10
- Search Settings 95
- Set Up Your Phone 3
- Settings
 - Overview 88
- Setup Screens 13
- Share
 - Contacts 43
- SIM Card 8
- Sound Settings 94
- Specifications 112
- Status Bar 23
- Status Icons 24
- Stopwatch 83
- Storage Settings 104
- System Updates Settings 109

T

- Take Pictures and Record Videos 69
- Text and Multimedia Messaging 46
- Text Entry 19
- Text Messaging
 - Conversations 48
 - Draft messages 48
 - Notifications 48
 - Options 49
 - Send messages 46

- Timer 83
- Touchscreen
 - Turn off 20
 - Turn on 20
- Troubleshooting 112
- TTY Mode 36
- Turn Device Off 12
- Turn Device On 12
- Typing 19

U

- USB Storage Settings 104

V

- Video Camera
 - Record video 70
- Videos
 - Record 70
 - View 71
- Virgin Account Information and Help 113
- Voicemail 33
 - Setup 33
- Volume 94
 - Key 4

W

- Wallpaper 95
- Wi-Fi 59
 - Settings 60, 89
 - Turn On and Connect 59

Y

- Your Phone's Home Screen 23